



**Jayco**<sup>®</sup> Generations of family fun.

2020

# EAGLE

FW, FW HT AND FW HTX  
FIFTH WHEEL TOWABLES

OWNER'S MANUAL





# eco advantage™

THE JAYCO ECOADVANTAGE IS OUR COMPANY'S COMMITMENT TO PROTECTING THE ENVIRONMENT. Through Jayco's company-wide sustainability program, we're creating better ways to build better RV's using fewer natural resources. Already, our initiative has created significant impact. As of 2014 our company has:

## Recycled



- 7,192 tons of wood
- 2,354 tons of scrap metal
- 1,428 tons of cardboard and paper

## Conserved



- 9,997,400 gallons of fresh water, enough to meet the daily needs of 133,293 Americans.
- 34,277 gallons of gas, enough for Americans to drive more than 957,600 miles.
- Enough electricity to power 1,745 homes for a year.

## Saved



- 60,900 mature trees.
- Enough landfill airspace to meet the annual disposal needs of a community of 44,683 people.

We're proud of our results, and we know those numbers show that a little initiative can go a long way. The Jayco EcoAdvantage is our way of making sure endless generations can enjoy the Great Outdoors.





# Table of Contents

---

## **SECTION 1: WARRANTY & SERVICE**

---

Factory Tours	11
Options and Equipment	11
Dealer Responsibility	11
Customer Relations	11
To Contact Us	13
About This Manual	13
Warranty Packet	14
Safety Alerts	14
Reporting Safety Defects	15
Customer Responsibility	16
Change Of Address/Ownership	16
Suggestions For Obtaining Service	16
Obtaining Service For Separately Warranted Items	17
Obtaining Service At Our Customer Service Facility	17
Parts and Accessories	17

---

## **SECTION 2: OCCUPANT SAFETY**

---

Secondary Means of Escape (Exit Window)	23
<i>Exit Window Label</i>	
Fire Safety	24
Fire Extinguisher	24
Smoke Alarm	25
Combination Carbon Monoxide /Propane Alarm	26
Formaldehyde	29
Extended Or Full Time Usage	29
Cold Weather Usage	30
Condensation	30

---

## **SECTION 3: PRE-TRAVEL INFORMATION**

---

Tow Vehicle	31
Vehicle Labels	31
Weight Terms	31
Weight and Capacity Labels	31
<i>OCCC Label (yellow)</i>	
<i>Federal Certification Label</i>	
<i>Tire and Loading Information</i>	
Loading Your Recreation Vehicle	33
Cargo Carrying Accessory Receiver (if so equipped)	33
Rear Bumper	34
Fifth Wheel Pin Box (customer supplied)	34
Fifth Wheel Pin Box	35
Fifth Wheel Pin Box Height	35
Fifth Wheel Hitching Procedure	35
Wire Harness/Connector Plug	36
Weighing Your Tow Vehicle and RV	36

---

## **SECTION 4: VEHICLE OPERATION**

---

Towing	39
RV Brake System	39
Electric Brakes	40
Brake Controller (customer supplied)	40
Travel Trailer Breakaway Switch	40
Hydraulic Brakes (if so equipped)	41
Disc Brakes (if so equipped)	41
Towing Behind Your RV	41

## Table of Contents

Factory Installed Hitch Reciever (if so equipped)	42
Entrance Door Step(s)	44
Stowable Entrance Door Step (if so equipped)	44
Entrance Door	45
Rear Backup Camera Prep	46
Campsite Hook-Up	46
LCI 3.0 Leveling System (if so equipped)	46
Auto Leveling Touch Pad	48
OneControl Touch Panel	49
<i>OneControl Touch Panel</i>	
Linc Remote Control	50
<i>Linc Remote</i>	
Troubleshooting	50
Stabilizer Jacks	51
Manual Stabilizer Jacks (if so equipped)	51
Electric Stabilizer Jacks (if so equipped)	51
Emergency Stopping	52
Emergency Towing	52
Wheel Lugs	53
Wheel Lug Nut Diagrams	53
Wheel Lug Nut Torque Values	54
Tires	55
Changing A Tire	57
Spare Tire Carrier (if so equipped)	58
Hoist Mount	58
<i>Bracket Mount Travel Position</i>	
<i>Hoist Mount Travel Position</i>	
Bumper Mount:	59
<i>Bumper Mount</i>	
<i>Crank Access Port</i>	
Setting Up Your Recreation Vehicle	60
Travel Trailer Set Up	60
Fifth Wheel Set Up	60
Awnings (if so equipped)	60
Awning Care	61
Electric Patio Awning With Remote Control	61
In Motion Detector (if so equipped)	61
<hr/> <b>SECTION 5: SLIDEOUT SYSTEMS</b>	
Electric Slide Room(s) (if so equipped)	63
General Slideout Operation	63
<i>Slideout Overlap-Outside</i>	
General Slideout Troubleshooting Checklist	64
Flush Floor Slideout	64
Schwintek In-Wall Slideout System	66
Error Codes	69
Norco Slideout System	69
Norco Slideout Manual Operation	70
Power Gear Slideout System	70
<i>Fig.1 Slideout Controller</i>	
Power Gear Slim Rack Slideout System	72
Operating the Slideout	72
Power Gear Ram Slideout System	76

# Table of Contents

## **SECTION 6: ELECTRICAL SYSTEM**

---

The Electrical System	79
In Case Of An Electrical Fire	79
Command Center	80
<i>Command Center Panel</i>	
<i>Command Center Panel w/Switch Modules</i>	
GFCI Receptacle	81
LCI One Control® System	81
5-Way and 8-Way Power Remote (if so equipped)	83
Testing the Campsite Power Connection	87
Connecting the Power Cord	87
Inverter (if so equipped)	88
Power Converter	89
Converter with Charge Wizard (if so equipped)	91
12-Volt DC System	91
12-Volt Fuse Panel	91
Auxiliary Battery (customer supplied)	92
Replacing a Fuse	92
12-Volt DC Outlet	92
Dry Camping	93
Replacement and Maintenance	93
Battery Isolator For Your Tow Vehicle (customer supplied)	93
Battery Disconnect Switch (if so equipped)	93
Load Center	94
<i>Battery Disconnect Switches</i>	
120-Volt Circuit Breakers	94
Approximate Electrical Load Ratings	96
120-Volt (30 AMP) AC System (if so equipped)	97
30-amp Power Cord (if so equipped)	97
120-Volt (50 AMP) AC System (if so equipped)	98
Calculating 30 AMP Electrical Load (if so equipped)	98
50-AMP Power Cord (if so equipped)	99
Calculating 50 AMP Electrical Load (if so equipped)	99
Solar Prep (if so equipped)	100
Replacing Light Bulbs	100
<i>Solar Plug</i>	

## **SECTION 7: FUEL & PROPANE SYSTEM**

---

Exhaust Gas Fumes	101
Propane Gas System	101
Propane Gas Container	102
Servicing or Filling	103
<i>"Shut off for re-fueling" Label</i>	
<i>"Do not fill to more than 80%" Label</i>	
LP Gas Container Overfill	104
Maintenance	104
Propane Cylinder Recertification	104
Hoses, Pipes, Tubes and Fittings	104
Propane Regulator	105
Propane Use and Safety	106
Propane Leak Test	106
Using the Propane System	106
<i>Propane System Label</i>	
Cooking With Propane Gas	107
<i>Cooking / Comfort Heating Label</i>	

# Table of Contents

Calculating Propane Gas Usage	107
Traveling With Propane	108
Installing Propane Cylinder(s)	108
<i>Refueling Warning Label</i>	
<i>Single Cylinder</i>	
<i>Main Supply Hose</i>	
<i>Double Cylinder</i>	
<i>Two Propane Cylinders</i>	

## **SECTION 8: PLUMBING SYSTEM**

---

Plumbing System	111
Plumbing System Maintenance	111
Monitor Panel	111
Operation	111
<i>Monitor Panel</i>	
Fresh Water System	112
<i>Command Center</i>	
Water Pressure Regulator (customer supplied)	113
Fresh Water Holding Tank	113
12-Volt Water Pump and Switch	113
Draining the Fresh Water System	114
<i>Exterior Fresh Water Drain</i>	
<i>Low Point Drains</i>	
Utility Center – 2 Valves (6 In 1)	115
Sanitizing the Plumbing System	119
Winterizing (with Utility Center)	122
Air Pressure Method	123
Winterizing with Antifreeze Method	124
Nautilus P2.5 Uni-Dock Utility Center	126
Winterizing the Plumbing System	133
Winterize with Air Pressure	134
Winterize the Black Tank Flush	135
Draining the Spray Port	136
Winterizing the Spray Port with Antifreeze	136
Winterize with Antifreeze Method	136
Water Heater	139
Gas/Electric DSI Tank (Storage) Water Heater System (if so equipped)	139
<i>Anode Rod Replacement Chart</i>	
Outside Shower (if so equipped)	143
Faucets	144
Bathroom Tub / Shower	144
Black/Grey Water System and Tanks	145
Black and Grey Tank Drains	146
Macerator Pump System (if so equipped)	147
<i>Black/Grey Tank Drain and Valves</i>	
Black Tank Flush (if so equipped)	149
<i>Tank Flush Inlet</i>	
Black Tank Flush (if so equipped)	150
Tank Heaters (if so equipped)	151
Toilet	152
Spray Port (if so equipped)	153

# Table of Contents

## **SECTION 9: HEATING & COOLING**

---

Air Conditioner	155
Roof Mount (if so equipped)	155
Wall Mount (if so equipped)	155
Heat Pump Operation (if so equipped)	155
Power Roof Vent (if so equipped)	155
<i>Attic Fan Control</i>	
Ceiling Fan (if so equipped)	156
Furnace	156
Fireplace (if so equipped)	157

## **SECTION 10: APPLIANCES**

---

Microwave	159
Cooking Safety	159
In Case Of a Grease Fire	159
Cooktops: Range and Oven (if so equipped)	160
Electric Drop-In Cooktops (if so equipped)	160
Cooking with Propane (if so equipped)	160
Gas Drop-In Cooktops (if so equipped)	161
Kitchen Range and Oven (if so equipped)	161
Oven (if so equipped)	161
Gas BBQ Grill (if so equipped)	162
<i>Gas Grill and Mounting</i>	
<i>Bracket on Support Rail</i>	
Attaching the “Quick Coupler” Connection	163
<i>Quick Connect Coupler</i>	
Range Hood (if so equipped)	164
Refrigerator	164
Cleaning the Interior	165
Cleaning the Exterior	166
Washer/Dryer Prep (if so equipped)	166
Vacuum Systems (if so equipped)	166
<i>Dryer Vent Label</i>	
Water Heater – See Plumbing Section	167
Outside Kitchen (if so equipped)	167
<i>Quick Connect Coupler</i>	
Exterior Refrigerator	168
LP Gas Grill (if so equipped)	168

## **SECTION 11: ELECTRONICS**

---

HDTV Antenna/Satellite System(s)	171
HDTV Antenna (if so equipped)	171
Antenna Power Supply (if so equipped)	171
<i>Antenna Power Supply</i>	
Satellite (if so equipped)	171

## **SECTION 12: INTERIOR**

---

Cleaning The Interior	173
Window Treatments	173
Cabinetry and Tables	174
Interior Wall Panel	174
Quik Panel Wall Panels (if so equipped)	174
ABS Plastics	175
Sofa and Dinette	175
Hide-A-Bed Sofa or Sofa Sleeper	175

Jack Knife Sofa	175
Trifold Sofa	175
Cube Sofa	176
Booth Dinette (if so equipped)	176
Free-Standing Table and Chairs (if so equipped)	176
Pantry or Hutch (if so equipped)	177
Countertops	177
Laminate Countertops (if so equipped)	177
Solid Surface Countertops (if so equipped)	177
Flooring	178
Carpet	178
Vinyl Flooring	178
Murphy Bed (if so equipped)	178
Bed Storage	181
Prop Rod (if so equipped)	181
Gas Struts (if so equipped)	182
Loft Sleeping Area (if so equipped)	182
Bunk Beds (if so equipped)	183
Bunk Bed Ladder (if so equipped)	183

---

### **SECTION 13: EXTERIOR**

Cleaning the Exterior	185
Frame	187
E-Z Lube or Super-Lube Axle (if so equipped)	187
Exterior Roof and Sidewall Vents	188
Windows	188
Exterior Ladder (if so equipped)	188
Sealants	189
Fifth Wheels - Sealant Diagram	190

---

### **SECTION 14: TRAVEL/CAMPING/STORAGE CHECKLISTS**

Travel Checklist	191
RV Storage	192

---

### **SECTION 15: ADDITIONAL INFORMATION**

Featured Components Quick Reference Chart	195
Vehicle Maintenance Record	197
Ownership Notification	198



**WARNING: Read all instructions in this manual and component manufacturer supplied information before using your RV.**

This manual has been provided by your recreational vehicle manufacturer for the sole purpose of providing instructions concerning the operation and maintenance of this recreational vehicle. Nothing in this manual creates any warranty, either expressed or implied.

**The owner's failure to provide required service and/or maintenance could result in the loss of warranty.** Please review the limited warranty and the limited warranties that apply to specific components offered with this vehicle.

Instructions are included in the manual for operating various components which are optional on some RV's or may not be available on your particular model. **"If so equipped" does not indicate or imply that the component(s) or option(s) were at any time available, or can be retrofitted to your model.** In addition, the owner should refer to individual manufacturer's operating instructions contained in the owner's packet.





*Congratulations!* Thank you for selecting a Jayco recreation vehicle. We are excited to welcome you to our growing RV family. We are committed to being the most respected name in RVs. We invite you to drop by our Visitors Center located in Middlebury, Indiana. Jayco recreation vehicles are manufactured for use as temporary living quarters for recreation, camping and travel uses, all as defined by the bylaws of the Recreation Vehicle Industry Association (RVIA).

This recreation vehicle is not intended for use as a full-time residence or for commercial use. Commercial use means using the recreation vehicle as a business asset such as a mobile office or using the recreation vehicle for lease or rental purposes.

Jayco reserves the right to discontinue or change specifications or design at any time without notice and without incurring any obligation whatsoever. Recreation vehicles built for sale in Canada may differ to conform to Canadian Codes.

### **Factory Tours**

To book a factory tour or check on available tour times (free admission, closed holidays) please log on to <https://www.jayco.com> and hold the mouse pointer on the **ABOUT JAYCO** heading. Select “**FACTORY TOURS**” from the drop down menu that opens.

### **Options and Equipment**

Jayco recreation vehicles are available in several sizes and models, so accessories and components may differ slightly between models. Some equipment described in this manual may not apply to your recreation vehicle.

Jayco reserves the right to discontinue or change specifications or design at any time without notice, and to make additions or improvements without incurring any obligations upon itself to install these changes on its products previously manufactured. Recreation vehicles built for sale in Canada may differ to conform to Canadian Codes.

### **Dealer Responsibility**

At the time of sale of the new recreation vehicle, your Jayco dealer is expected to:

- Deliver your recreation vehicle in the best condition possible. Your recreation vehicle must pass the dealer’s pre-delivery inspection (PDI), including all systems tests.
- Provide orientation of the recreation vehicle, its systems, components and operation.
- Request that you read all warranty information and explain any provision not clearly understood.
- Ensure you receive the Warranty Packet. Your dealer can assist you in completing the OEM warranty cards or registrations, and locate any required component model or serial numbers.
- Complete and return the “Warranty Registration and Customer Delivery Form” to Jayco within 10 days of delivery to activate the applicable warranty coverage.

The **Limited Warranty** is activated only after Jayco receives a signed and dated “Warranty Registration and Customer Delivery Form” from your dealer.

### **Customer Relations**

Jayco has empowered its dealers to make warranty and repair decisions.

If a special circumstance occurs that requires information from Jayco, we have asked your dealer’s service management to make the contact on your behalf. **This is why you should always talk to your dealer’s service management first.**

## **SECTION 1: WARRANTY & SERVICE**



**NOTE:** Please provide the following information when contacting us for assistance:

- Customer name and current location.
- Phone number where you can be reached.
- 17-digit chassis Vehicle Identification Number (VIN) or 9-digit Serial.
- The current vehicle mileage (motorhomes).
- Your date of purchase.
- If applicable, the component description, serial number and model number.
- A detailed description of the concern.
- The name of your selling dealer.
- If different from above, the contact information for the RV repair facility you are contacting Jayco to discuss.

### **An important note about alterations and warranties**

Installations or alterations to the original equipment vehicle as distributed by Jayco are not covered by the Jayco Limited Warranty. The special body company, assembler, equipment installer or up fitter is solely responsible for warranties on the body or equipment and any alterations (or any effect of the alterations) to any of the parts, components, systems or assemblies installed by Jayco. Jayco is not responsible for the safety or quality of design features, materials or workmanship of any alterations by such suppliers.

### **Obtaining Emergency Warranty Repair**

1. Call 1-(800)-283-8267 or use our website dealer locator to find an authorized Jayco dealer in your area. Contact them for an appointment; they will handle all warranty repair billing and returned parts for you.
2. If you cannot locate an authorized Jayco dealer near you, ask the campground staff for referrals or check the local telephone yellow pages. Or contact Jayco Customer Service or your selling dealer for assistance in locating a repair facility.
  - Contact the RV repair facility to discuss your situation and make an appointment. Ask how their billing will be handled. They may choose to bill Jayco directly; otherwise, you are expected to pay them.
  - Have the RV repair facility inspect your RV. Either they or you must call Jayco Customer Service to discuss applicable warranty coverage prior to any repair work being performed.
  - Jayco Customer Service will issue an authorization number upon warranty repair approval and advise if any original parts need to be returned.
  - Once Jayco Customer Service has issued an authorization number, the RV repair facility may begin actual repair to your RV.
  - Inspect the completed repair work thoroughly. If you are not satisfied, communicate that immediately to the RV repair facility management. Make sure you are satisfied with the repair before you pay or leave the premises.
  - For reimbursement, either you or the RV repair facility must send a copy of your itemized repair bill and all requested return parts by UPS (regular ground, freight pre-paid) within 60 days of the completed repair date.

*To expedite processing your warranty claim, include your name, address, phone number, RV 17-digit VIN and authorization number. If returning parts, include a copy of your return freight bill.*

### **Obtaining weekend or after business hours repair assistance**

If an authorized Jayco dealer is not located nearby, contact your selling dealer for assistance. If your dealer is closed, check with the campground staff or telephone yellow pages for an RV repair facility. Have the item repaired and contact Jayco Customer Service immediately the following business day.

*Failure to contact Jayco Customer Service, unauthorized or improper warranty repairs, or failure to return requested original parts may result in loss of reimbursements and/or loss of warranty.*

### **To Contact Us**

#### **Mailing address**

Jayco, Inc.  
Customer Service  
P.O. Box 460  
903 S. Main Street  
Middlebury IN 46540  
Phone (toll-free)  
Phone (local)  
Fax (toll-free)  
Brochure request  
Parts email  
Service email  
Website

#### **Shipping address**

Jayco, Inc.  
Customer Service  
100 Bontrager Drive  
Bldg 42 Door 4220  
Middlebury IN 46540  
(800) 283-8267  
(574) 825-0608  
(866) 709-9139  
[info@Jayco.com](mailto:info@Jayco.com)  
[parts@Jayco.com](mailto:parts@Jayco.com)  
[service@Jayco.com](mailto:service@Jayco.com)  
[www.Jayco.com](http://www.Jayco.com)

### **Jayco Travel Club**

All owners of Jayco recreation vehicles are eligible for membership in the Jayco Travel Club.

The club promotes family camping and the active use of your RV with others who have similar interests in the RV lifestyle.

One "International Rally" is held each year in various locations around the United States and Canada. In addition, the club offers a variety of local and regional activities throughout the year.

By belonging to the Jayco Travel Club, you will find new ways to enjoy your RV and make friends all across the country.

For more information, please visit [www.Jaycorvclub.com](http://www.Jaycorvclub.com) or call 1-800-262-5178.

## **ABOUT THIS MANUAL**

This manual is a guide to operation of the features, equipment and controls in your recreation vehicle. If you find components vary significantly from what is described, please contact your dealer to ensure you have the correct information. Nothing in this manual creates any warranty, either expressed or implied.

This Owner's Manual and Warranty Packet are to be considered permanent components of the vehicle. Keep them in your recreation vehicle at all times for personal reference. If the recreation vehicle is sold, they should remain with the vehicle for the next owner. Nothing in this manual creates any warranty, either expressed or implied, nor does it cover every possible detail of equipment, standard or option, installed on or in your recreation vehicle.

*Information, illustrations and specifications in this manual reflect the most current available at the time of publication approval, are subject to change and not intended to indicate actual size.*

## SECTION 1: WARRANTY & SERVICE

### **WARRANTY PACKET**

There are components that are excluded from the vehicle warranty, or are warranted separately by their own individual manufacturer's limited warranty. The Warranty Packet contains these component manufacturer supplied manuals or information sheets, warranty cards and/or registrations. Consult this information for questions regarding operating, maintenance, servicing instructions and warranty coverage. It is important you complete and mail warranty cards and registrations within the prescribed time limits to avoid loss of warranty coverage.

### **SAFETY ALERTS**

Throughout this manual, certain items are labeled **NOTE**, **CAUTION**, **WARNING**, and **DANGER**. These terms will alert you to precautions that can involve risk to your vehicle or to your personal safety.

Read and follow them carefully. National Safety Associations and organizations require many of the instructions listed. Always use the appropriate safety gear when servicing or maintaining your recreation vehicle. Please call your dealer or our customer service representatives if you are unsure how to proceed.

These signal words indicate precautions and potential situations, which if not avoided, may result in personal injury, property damage, or damage to your recreation vehicle. These precautions are listed in the appropriate areas in this Owner's Manual, and in the information contained in the Warranty Packet, and on safety labels affixed to your recreation vehicle. Read and follow them carefully.



**NOTE:** Gives helpful information.



This is the safety alert symbol. It is used to alert you to potential personal injury hazards. Obey all safety messages that follow this symbol to avoid possible injury or death.

## ***NOTE***

Indicates a potential situation that, if not avoided, may result in property damage or damage to your RV.



## **CAUTION**

Indicates a potentially hazardous situation that, if not avoided, may result in minor or moderate injury. It may also be used to alert against unsafe practices.



## **DANGER**

Indicates an imminently hazardous situation that, if not avoided, will result in death or serious injury. This alert information is limited to the most extreme situations.

** WARNING**

Indicates a potentially hazardous situation that, if not avoided, may result in death or serious injury.

**REPORTING SAFETY DEFECTS**

**In the United States:** If you believe that your recreation vehicle has an alleged defect which could cause a crash or cause injury or death, you should immediately inform the National Highway Traffic Safety Administration (NHTSA), in addition to notifying our Customer Service Department.

If NHTSA receives similar complaints, it may open an investigation, and if it finds that a safety defect exists in a group of vehicles, it may order a recall and remedy campaign.

However, NHTSA cannot become involved in individual problems between you, your dealer or your vehicle manufacturer. For additional information, please refer to the NHTSA website at [www.safercar.gov](http://www.safercar.gov).

**To contact NHTSA by phone:**

Call the Department of Transportation (DOT) Vehicle Safety Hotline at 1-888-327-4236, and a NHTSA representative will record your complaint information (TTY: 1-800-424-9153 or 1-202-484-5238).

**To Contact NHTSA by mail:**

Office of Defects Investigations/CRD  
NVS-216  
1200 New Jersey Ave SE  
Washington, DC 20590

**In Canada:** If you believe your vehicle has an alleged safety defect, you should contact Transport Canada and our Customer Service Department immediately. Transport Canada prefers to be called instead of posted mail or email as it enables their investigators to confirm that your information is correct, and to answer your questions accurately. For additional information, please refer to the Transport Canada website at [www.tc.gc.ca](http://www.tc.gc.ca).

**To contact Transport Canada by phone:**

Call 1-800-333-0510 (or 1-613-993-9851 if you are calling from the Ottawa region) and ask to speak to a defect investigator.

**To contact Transport Canada by mail:**

Road Safety and Motor Vehicle  
Regulation Directorate  
Transport Canada  
Tower C, Place de Ville  
330 Sparks Street  
Ottawa, Ontario K1A 0N5

## **SECTION 1: WARRANTY & SERVICE**

### **CUSTOMER RESPONSIBILITY**

It is important you read and understand all instructions and precautions before operating the recreation vehicle. Even if you are an experienced RV'er we encourage you to thoroughly read this Owner's Manual, as well as the information contained in your Warranty Packet and Chassis Guide (motorized only).

As technology advances, new improvements enter the RV industry every day, and each RV manufacturer has its own unique manufacturing process.

Familiarize yourself with the Limited Warranty applicable to your recreation vehicle. There are components that are excluded or warranted separately by their individual manufacturer's limited warranty (refer to the Warranty Packet or Chassis Guide if applicable).

As the new owner of the recreation vehicle, you are responsible for regular and proper maintenance performed in accordance with this manual and the OEM manuals. Regular and proper maintenance will help prevent conditions arising from neglect that are not covered by the limited warranty. It is your responsibility and obligation to return your vehicle to your dealer for repairs and service.

### **CHANGE OF ADDRESS/OWNERSHIP**

Please notify our Customer Service Department as soon as possible of a change of address by writing or calling us. For notification of a change of ownership, please fill out the appropriate form located in this manual and mail it to Customer Service along with documentation showing proof of ownership. Please include your current vehicle mileage (motorized only).

### **SUGGESTIONS FOR OBTAINING SERVICE**

To help ensure your dealer provides the level of service you expect, here are some suggestions we would like to make:

**Contact your dealer at once...** Do not wait until you are ready to use your RV. Your dealer may not be able to service it immediately and/or the repair may require parts be ordered. The dealer's service department is busiest on Mondays, Fridays and before the holidays.

**Prepare for the appointment...** If you are having warranty work performed, be sure to have the right papers with you. Take your warranty folder and have your vehicle information available. All work to be performed may not be covered by the warranty. Discuss additional charges with the service personnel.

**Prepare a list...** Provide your dealer with a written list of specific repairs needed. It is important that you provide any vehicle repair history to the dealer's service personnel.

Keep a maintenance log of your vehicle's service history. This can often provide a clue to the current issue.

**Be reasonable with your requests...** If you leave a list with several items and you need your vehicle returned back by a specific time, discuss the situation with the dealer's service personnel and list your items in order of priority. This may include making a second appointment for work not completed or parts that the dealer may need to order.

**Don't expect to look over the technician's shoulder...** Please don't be offended if you are told you cannot watch the work being done. Some insurance requirements forbid admission of customers to the service area.

**Inspect the work performed...** Finally, check out the service or repair job when you pick up your vehicle. Notify the dealer's service personnel immediately of any dissatisfaction. If you cannot return the vehicle immediately for repair, make an appointment as soon as possible.

## **SECTION 1: WARRANTY & SERVICE**

Please be aware that all service shops require notification of any issues with their repairs within a specified time limit. Make sure you are familiar with their repair policies.

### **OBTAINING SERVICE FOR SEPARATELY WARRANTED ITEMS**

Your selling dealer is responsible for servicing your recreational vehicle before delivery, and has an interest in your continued satisfaction. We recommend your dealer perform all inspection, warranty and maintenance services. Some dealers may be authorized service centers for those OEMs whose products are warranted separately and excluded from the **Limited Warranty**.

### **OBTAINING SERVICE AT OUR CUSTOMER SERVICE FACILITY**

Should your recreation vehicle be in need of service, and your dealer recommends that the repairs be made at our Customer Service facility, your recreation vehicle may be returned to us with the following guidelines\*:

- You or your dealer must make a confirmed appointment 60 days prior to dropping off the recreation vehicle at our Customer Service facility.
- The holding tanks must be emptied and rinsed. We have a dumping station available for customer use.
- The propane system (if so equipped) and all electrical systems must be shut down and turned off. We are not responsible for discharged batteries or propane tanks.
- During the appropriate season, please ensure the RV has been winterized.
- Unless prior approval has been obtained from our Customer Service facility, all personal items must be removed from the area where you are requesting service repair and the refrigerator emptied. We are not responsible for loss of food items.
- All transportation costs are the responsibility of the owner. You may need to arrange for alternative accommodations for some types of repairs. Please be prepared accordingly.

*\*Our Customer Service facility occasionally utilizes local independent repair facilities. Your vehicle may be referred to or repaired by one of these local repair facilities.*

### **PARTS AND ACCESSORIES**

Contact your authorized dealer for assistance in obtaining replacement parts or accessories. We do not sell direct to retail or non-authorized dealers. If the original part is no longer available, we will make every effort to provide an appropriate substitute.

**JAYCO TOWABLE LIMITED WARRANTY**

**WHAT AND WHO IS COVERED**

This Limited Warranty covers only recreational vehicles sold in, and that remain in, the United States, U.S. Territories and Canada and used for the intended purpose of recreational travel and camping. If a substantial defect in material or workmanship, attributable to Jayco, is found to exist and is reported to Jayco or an authorized servicing dealer during the applicable warranty period, it will be repaired or replaced, at Jayco's option, without charge to the RV owner, in accordance with the terms, conditions and limitations of this limited warranty.

This limited warranty applies to the first consumer purchaser of a new RV only. All rights and limitations within this warranty are applicable to the original owner of the RV only. You may contact an independent, authorized dealer for details.

Jayco's obligation to repair or replace defective materials or workmanship is the sole obligation of Jayco under this limited warranty. Jayco reserves the right to use new or remanufactured parts of similar quality to complete any work, and to make parts and design changes from time to time without notice to anyone. Jayco reserves the right to make changes in the design or material of its products without incurring any obligation to incorporate such changes in any product previously manufactured. Jayco makes no warranty as to the future performance of this RV, and this limited warranty is not intended to extend to the future performance of this RV, or any of its materials, components or parts. In addition, the RV owner's obligation to notify Jayco, or one of its independent, authorized dealers, of a claimed defect does not modify any obligation placed on the RV owner to contact Jayco directly when attempting to pursue remedies under state or federal law.

**LIMITATIONS, EXCLUSIONS AND DISCLAIMER OF IMPLIED WARRANTIES:**

**ANY IMPLIED WARRANTY THAT IS FOUND TO ARISE BY WAY OF STATE OR FEDERAL LAW, INCLUDING ANY IMPLIED WARRANTY OF MERCHANTABILITY OR ANY IMPLIED WARRANTY OF FITNESS, IS LIMITED IN DURATION TO THE DURATION SET FORTH IN THIS LIMITED WARRANTY AND IS LIMITED IN SCOPE OF COVERAGE TO THE SCOPE OF COVERAGE OF THIS LIMITED WARRANTY. ALL IMPLIED WARRANTIES AND CONDITIONS, STATUTORY OR OTHERWISE, ARE DISCLAIMED IN THEIR ENTIRETY AS TO RVs OR COMPONENTS OF RVs EXCLUDED OR NOT COVERED UNDER THIS WARRANTY.**

Jayco makes no warranty of any nature beyond that contained in this limited warranty. Jayco does not authorize any person to create any other obligation or liability for it regarding this RV, and Jayco is not responsible for any representation, promise or warranty made by any dealer or other person beyond what is expressly stated in this limited warranty, and no one has the authority to enlarge, amend or modify this limited warranty. Any selling or servicing dealer is not Jayco's agent, but an independent entity.

**JAYCO SHALL NOT BE LIABLE FOR ANY INCIDENTAL OR CONSEQUENTIAL DAMAGES THAT MAY RESULT FROM BREACH OF THIS LIMITED WARRANTY OR ANY IMPLIED WARRANTY. BY WAY OF EXAMPLE, CONSEQUENTIAL DAMAGES INCLUDE FUEL AND TRANSPORTATION EXPENSES TO DELIVER THE RV TO A SERVICING DEALER, HOTEL ROOMS, LOST WAGES AS WELL AS CONSEQUENCES OF MOISTURE DAMAGE SUCH AS MOLD AND MILDEW AS WELL AS RUST AND CORROSION. THIS EXCLUSION OF CONSEQUENTIAL AND INCIDENTAL DAMAGES SHALL BE INDEPENDENT OF ANY FAILURE OF THE ESSENTIAL PURPOSE OF ANY WARRANTY, AND THIS EXCLUSION SHALL SURVIVE ANY DETERMINATION THAT THIS LIMITED**



**WARRANTY OR ANY IMPLIED WARRANTY HAS FAILED OF ITS ESSENTIAL PURPOSE.**

Some states do not allow limitations on how long an implied warranty lasts, or the exclusion or limitation of incidental or consequential damages, so the above limitations or exclusions may not apply to you.

**THE PERIOD OF COVERAGE**

The duration of this Limited Warranty is 2 years. The warranty period begins on the date that the RV is delivered to the first retail purchaser by an independent, authorized dealer of Jayco, or, if the dealer places the vehicle in service before retail sale, on the date the RV is first placed in such service.

**HOW TO GET SERVICE**

It is normal to expect some warranty service during the term of this Limited Warranty. To obtain warranty service the owner must do all of the following:

1. Notify an independent, authorized dealer of Jayco, or Jayco, of the substantial defect in material or workmanship attributable to Jayco, within the warranty coverage period designated above;
2. Provide the notification mentioned in (1), above, within ten (10) days of when the owner discovered, or should have discovered, the substantial defect in material or workmanship attributable to Jayco;
3. Promptly schedule an appointment with and take the RV to an independent, authorized dealer of Jayco, or Jayco, for repairs; and
4. Pay any freight or transportation costs, import duties, fees and all incidental expenses associated with obtaining warranty service.

If you need assistance, you may contact Jayco, at 903 S. Main Street, P.O. Box 460, Middlebury, Indiana 46540, Attn: Customer Service, (574) 825-5861, (800) 283-8267 or [www.jayco.com](http://www.jayco.com).

NOTE: Jayco does not control the scheduling of service work at the independent, authorized dealerships. You may encounter some delay in scheduling or completion of work. Also, you must notify the selling dealer at time of delivery to have work performed on any defect that occurred at the factory during manufacture at no cost to you as provided by this limited warranty. (See below under WHAT IS NOT COVERED).

If two (2) or more service attempts have been made to correct any covered defect that you believe impairs the value, use or safety of the RV, or if it has taken longer than thirty (30) days for those types of repairs to be completed, you must, to the extent permitted by law, notify Jayco directly, in writing, at the above address, of the unsuccessful repair(s) of the alleged defect(s) so that Jayco can become directly involved in making sure that you are provided service pursuant to the terms of this limited warranty.

Jayco's obligation is to address, within industry standards, any covered substantial defect discovered and reported within the warranty coverage period provided: (1) you notify Jayco or an authorized dealer within 10 days of your discovery of the substantial defect; AND (2) you deliver the RV to Jayco or an authorized dealership at your cost and expense. If this primary remedy fails to successfully cure any substantial defect after a reasonable number of repair attempts, your sole and exclusive remedy shall be to have Jayco pay an independent service shop of your choice to perform repairs to the substantial defect. If the substantial defect is incapable of being repaired, your exclusive remedy will be to receive diminished value damages (i.e. the difference in your purchase price and the actual value of the RV on

## **SECTION 1: WARRANTY & SERVICE**

the date of purchase due to the substantial defect that is incapable of repair). You must exhaust the primary repair remedy and this back-up remedy and both these remedies must fail of their essential purpose before initiating any action against Jayco.

### **WHAT IS NOT COVERED**

By way of example only, this limited warranty does not cover any of the following:

- defects in materials, components or parts of the structure of the RV not attributable to Jayco;
- items that are added or changed after the RV leaves the possession of Jayco;
- additional equipment or accessories installed at any dealership, or other place of business, or by any other party, other than Jayco;
- any RV used for rental or other business or commercial purposes (Note: It shall be concluded that the RV has been used for commercial and/or business purposes if the RV owner or user files a tax form claiming any business or commercial tax benefit related to the RV, or if the RV is purchased, registered or titled in a business name or any business association such as a corporation or limited liability company);
- any RV sold or used outside the United States, U.S. Territories or Canada;
- any RV not used solely for recreational travel and camping;
- any RV purchased through auction or wholesale;
- any RV purchased from a dealer that is not an authorized dealer of Jayco;
- any defect arising from excess weight placed on the Structural Components;
- normal wear, tear or usage, such as tears, punctures, soiling, mildew, fading, or discoloration of exterior plastic or fiberglass, or soft goods, such as upholstery, drapes, carpet, vinyl, screens, cushions, mattresses and fabrics;
- the effects of condensation or moisture from condensation inside or outside the RV;
- mold or any damage caused by mold to the inside or outside of the RV;
- imperfections that do not affect the suitability of the RV for its intended purpose of recreational use or items that are working as designed but that you are unhappy with;
- exterior paint or finish;
- problems, including water leaks, related to misuse, mishandling, neglect or abuse, including failure to maintain the RV in accordance with the owner's manual, or other routine maintenance such as inspections, lubricating, adjustments, tightening of screws and fittings, tightening of lug nuts, sealing, rotating tires;
- damage due to accident, whether or not foreseeable, including any acts of weather;
- damage, rust, or corrosion due to the environment, theft, vandalism, fire, or other intervening acts not attributable to Jayco;
- damage caused by unregulated water pressure, tank over fill, or plumbing system modifications resulting in flooding of the vehicle;
- failure of the original retail purchaser or others to follow ordinary maintenance procedures as recommended by Jayco;
- damage caused by unprotected electrical hook-ups (home or campground), power surges, lightning, circuit overload, or electrical system modifications;

## **SECTION 1: WARRANTY & SERVICE**

- damage resulting from tire wear or tire failure;
- hydraulic leveling jacks or leveling system;
- defacing, scratches, dents, chips on any surface or fabric of the RV; damage caused by infestation by insects or animals;
- damage caused by off road use, overloading the RV or alteration of the RV, or any of its components or parts;
- wheel alignment or adjustments to axles when caused by improper maintenance, loading or damage from road hazards, including off road travel, wheel damage or balancing or damage from tire failures;
- any costs associated with obtaining service, including by way of example, travel costs, are specifically excluded from the coverage of this warranty;
- any RV used as a residence; and
- any component, system, or part of the RV that is warranted by another entity, including, by way of example, handling, braking, wheel balance, tires, tubes, batteries, gauges, generator, awning, hydraulic jacks, inverter, converter, microwave, television, DVD/CD player, radio, speakers, television, refrigerator, range, hot water heater, water pump, stove, carbon monoxide detector, smoke detector, propane detector, furnace or any air conditioner. The written warranty provided by any manufacturer of the component part is the direct responsibility of that manufacturer. Defects and/or damage to interior and exterior surfaces, trim, upholstery and other appearance items may occur at the factory. These items are usually detected and corrected at the factory or by the selling dealer prior to delivery to the retail customer. You must inspect your RV for this type of damage when you take delivery. If you find any such defect or damage you must notify the selling dealer at time of delivery to have these items covered by this limited warranty and to have work performed on the items at no cost to you as provided by this limited warranty.

### **EVENTS DISCHARGING JAYCO FROM OBLIGATION UNDER WARRANTY**

Certain things completely discharge Jayco from any obligation under this warranty and void it. By way of example, the following shall discharge Jayco from any express or implied warranty obligation to repair or replace any defect that results from: any rental or other business or commercial use or purchase of the RV (as defined in this warranty), any RV titled or registered in the name of any business or business association (such as a corporation or limited liability company), any RV sold outside of, or used outside of, the United States, U.S. Territories or Canada, through an auction or wholesale or by a non-authorized dealer, any defect in a separately manufactured component part, owner neglect or failure to provide routine maintenance (See Owner's Manual), unauthorized alteration, off road use, collision or accident, whether or not foreseeable, including any acts of weather or damage or corrosion due to the environment, theft, vandalism, fire, explosions, overloading in excess of weight ratings, and tampering with any portion of the RV, or any use of the RV as a semi-permanent or permanent home.

### **LEGAL REMEDIES**

**ANY ACTION TO ENFORCE ANY PORTION OF THIS LIMITED WARRANTY, OR ANY IMPLIED WARRANTY, MUST BE COMMENCED WITHIN NINETY (90) DAYS AFTER THE EXPIRATION OF THE WARRANTY COVERAGE PERIOD DESIGNATED ABOVE.** Any performance of repairs shall not suspend this limitation period from expiring, unless state law provides otherwise. Any performance of repairs after the warranty coverage period has expired, or performance of repairs regarding anything

## **SECTION 1: WARRANTY & SERVICE**

excluded from coverage under this limited warranty shall be considered “good will” repairs, and they will not alter the express terms of this limited warranty, or extend the warranty coverage period or this limitation period. In addition, this warranty is not intended to extend to future performance, and nothing in this warranty, or any action of Jayco, or any agent of Jayco, shall be interpreted as an extension of the warranty period or this limitation period. Some states do not allow a reduction in the statute of limitations, so this reduction may not apply to you. Jayco is not required to notify you if authorized repairs are considered “good will” by Jayco.

### **WARRANTY REGISTRATIONS**

Your warranty registration records should be completed and delivered to the manufacturers of component parts. The selling dealership will assist you in completing and submitting the Jayco product warranty registration form. That form must be returned to Jayco within ten (10) days of your taking delivery of the RV. Your Jayco warranty will not be registered unless this warranty registration is completed and received by Jayco. Failure to file this warranty registration with Jayco will not affect your rights under this limited warranty as long as you can present proof of purchase, but it can cause delays in obtaining the benefits of this limited warranty, and it may inhibit any servicing facility’s ability to provide proper repairs and/or part replacement. Note, tender and acceptance of a warranty registration does not alter the express terms of this limited warranty or any of its exclusions.

### **CARE AND MAINTENANCE**

It is the owner’s responsibility to perform proper care and maintenance of the RV, and to assure correct load distribution. For details regarding this, please see your Jayco owner’s manual and the owner’s manuals of the chassis manufacturer and other component part manufacturers. These outline various care and maintenance that is required to maintain your RV. Please review all manuals supplied with your RV, and contact your selling dealership or supplier of the component part if you have questions. Note: Failure to maintain the RV as noted in those manuals voids this limited warranty, and any damage to the RV as a result of your failure to perform such care, is not covered by this limited warranty.

**THIS WARRANTY GIVES YOU SPECIFIC LEGAL RIGHTS, AND YOU MAY ALSO HAVE OTHER RIGHTS THAT VARY FROM STATE TO STATE.**

### **ACCEPTANCE OF WARRANTY**

When you request or accept the performance of repairs under the terms of this Limited Warranty, you are confirming the acceptance of all terms of this Limited Warranty, including, by way of example, warranty limitations and disclaimers, the forum selection clause and the clause reducing the time period within which suit must be filed for breach.

### **LEGAL REMEDIES**

**EXCLUSIVE JURISDICTION FOR DECIDING LEGAL DISPUTES RELATING TO AN ALLEGED BREACH OF WARRANTY OR OTHERWISE RELATING TO YOUR PURCHASE OR OWNERSHIP OF THE RV MUST BE FILED IN THE COURTS WITHIN THE STATE OF INDIANA. THIS LIMITED WARRANTY SHALL BE INTERPRETED AND CONSTRUED IN ACCORDNACE WITH THE LAWS OF THE STATE OF INDIANA. THIS WARRANTY GIVES YOU SPECIFIC LEGAL RIGHTS, AND YOU MAY ALSO HAVE OTHER RIGHTS THAT VARY FROM STATE TO STATE OR PROVINCE TO PROVINCE. ALL ACTIONS OF ANY KIND RELATING TO THE RV SHALL BE DECIDED BY A JUDGE RATHER THAN A JURY.**

**JAYCO, INC.**

**903 S. Main Street \* P.O. Box 460 \* Middlebury, IN 46540**

**Telephone: 574-825-5861 or 800-283-8267**

**SECONDARY MEANS OF ESCAPE (EXIT WINDOW)**

Your recreation vehicle has been equipped with a window(s) that serves as a secondary means of escape. The window(s) will allow a quick exit from the vehicle during an emergency if access to the main entrance door is not available. It is easily identified by the red latches and label.

**Do not remove the EXIT window label from your RV:**

When parking your recreation vehicle, make sure the egress window is not blocked by trees or other obstacles. Make sure the ground below the window is solid and can be used as an escape path.



**Exit Window Label**

Practice opening the window before an emergency occurs, and make sure all occupants know how to operate it.

**⚠ CAUTION**

Exercise care when opening the exit window. If opened too far, it may come off the hinge. This may result in damage to the unit or window.



**NOTE:** All windows must be closed and locked while the RV is in transit.

Your recreation vehicle may be equipped with one of the following exit window styles:



**Flip latch style (2 per window)**

- Push up on the front lip of the latch and the latch unfolds.
- Push up on the front lip of the latch again to unhook the latch from the window.
- When both latches are released, push out on the window which is hinged at the top. Exit the vehicle.
- The screen does not need to be removed from the window.



**Slider window latch style**

- Pull the lever down to unlock the window.
- Slide the window to the right to open and exit the vehicle.
- The screen does not need to be removed from the window.

## **SECTION 2: OCCUPANT SAFETY**



### **Lever style latch**

Remove the screen by pulling the red tab (upper right arrow).

Pull the lever out from the sash clamps.

Swing the lever out so it is positioned straight out from the window.

Push the lever (and window) out to open and exit the vehicle.

## **FIRE SAFETY**

If a fire does start, follow these basic safety rules:

1. Call 911 and evacuate the vehicle immediately.
2. After everyone is accounted for, check the fire to see if you can attempt to put it out.
3. If it is large, or the fire is fuel-fed, get clear of the vehicle and have the Fire Department handle the emergency.
4. Do not attempt to use water to put out the fire. Water can spread some types of fire, and electrocution is possible with an electrical fire.

Refer to the following sections for additional fire safety information.

- Electrical Systems**, In case of an electrical fire.
- Appliances**, In case of a grease fire.

## **FIRE EXTINGUISHER**

Fire extinguishers are classified and rated by fire type, A, B and C. These classifications identify the kinds of fires or burning materials they are designed to fight.

**Class A** - Solid materials such as wood, paper, cloth, rubber and some plastics.

**Class B** - Liquids such as grease, cooking oils, gasoline, kerosene or other flammable liquids.

**Class C** - Electrical such as electrical wires or other live electrical equipment.

A dry chemical fire extinguisher has been installed by the entrance door. It is suitable for extinguishing small fires of the Class B or C type only.

We suggest you become thoroughly familiar with the operating instructions displayed on the side of the fire extinguisher.



**NOTE:** For information on how to use your fire extinguisher, refer to the fire extinguisher user's manual

### **Inspection and maintenance**

Read and follow all instructions on the label and user's manual provided by the fire extinguisher manufacturer.

- Inspect the extinguisher at least once a week (more frequently if it is exposed to weather or possible tampering). This should also be done before beginning a vacation or during an extended trip.

**⚠ WARNING**

Do not check the pressure, test or practice using the fire extinguisher by squeezing the trigger, even briefly. The fire extinguisher is not rechargeable or refillable. Once used, it will gradually lose pressure and will not be fully charged for use in an emergency.

**⚠ DANGER**

Do not turn the electrical power back on or plug in any appliances after the use of a fire extinguisher. Please refer to the fire extinguisher's user manual for further instructions on maintenance and clean up.

**SMOKE ALARM**

The smoke alarm will only work properly if it is operational and maintained. They have a limited life and will wear out over time. Immediately replace the detector if it is not working properly, if it displays any type of problem, or within five years of use. **Be sure to read, understand and follow the information provided by the smoke alarm manufacturer, including information on the limited life of smoke alarms.**

Be aware the smoke alarm is not fool proof and cannot detect fires if smoke does not reach it. Anything preventing smoke from reaching the alarm may delay or prevent an alarm.

Though the alarm horn in this detector meets or exceeds current UL standards, it may not be heard for reasons that include (but not limited to): a closed or partially closed door, other noise from electronics, appliances or traffic.

**⚠ WARNING**

This smoke alarm will not alert hearing impaired residents. Special alarms with flashing strobe lights are recommended for the hearing impaired

Only use the replacement battery recommended by the smoke detector manufacturer. The smoke detector alarm may not operate properly with other batteries. Never use a rechargeable battery as it may not provide a constant charge. Never disconnect the battery to silence the alarm.

Test the smoke alarm operation after the vehicle has been in storage, before each trip and at least once per week during use. Do not disconnect the battery or the alarm.

**The smoke alarm is operational once the battery is correctly installed.** It will not function if the battery is missing, disconnected, dead, the wrong type or not installed correctly. **It requires one standard 9V battery.** Refer to the user's guide, for correct battery and installation information,

**The LED light will indicate the battery is functioning properly.** When the production of combustion is sensed, the smoke detector sounds a loud alarm that continues until the air is cleared. The LED light will also give a visual indication of a sounding alarm.

**When the battery becomes weak, the alarm will "beep" about once a minute indicating a low battery.** This warning should last for 30 days. You **MUST** replace the battery once the alarms low battery warning (beep) starts to assure continued protection.

## SECTION 2: OCCUPANT SAFETY

When the battery is removed from the alarm, the battery flag will pop up; the alarm cannot be installed to the mounting bracket without a battery.

**To test**, stand at arm's length from the smoke alarm as the alarm horn is loud and may be harmful to your hearing. The test button will accurately test all functions. Never use an open flame to test the smoke alarm.

**Do not remove the warning label located near the smoke alarm from your recreation vehicle:**

### **Maintenance**

Vacuum off any dust on the cover of the smoke alarm using a soft brush attachment. Test the smoke alarm once you have vacuumed. Never use water, cleaners or solvents to clean the smoke alarm as they may damage the alarm. Do not paint the smoke alarm. Refer to the manufacturer's use guide for detailed maintenance information.

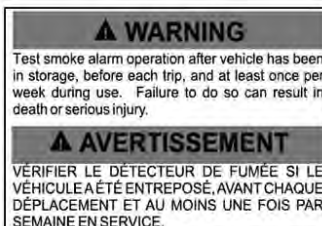

## COMBINATION CARBON MONOXIDE / PROPANE ALARM

Your recreation vehicle is equipped with a combination carbon monoxide (CO) / propane alarm that is listed for use in recreation vehicles. The combination carbon monoxide/propane alarm will only work if it is operational and maintained.

**⚠ WARNING**

- The carbon monoxide detector installed is intended for use in ordinary indoor locations of recreation vehicles. It is not designed to comply with Occupational Safety and Health Administration (OSHA) commercial or industrial standards.
- Do not disconnect the battery or the alarm.**
- Individuals with medical problems may consider using warning devices that provide audible and visual signals for carbon monoxide concentrations under 30 PPM.
- This alarm will only indicate the presence of carbon monoxide gas at the sensor. Carbon monoxide gas may be present in other areas.
- The ultimate responsibility for protection against toxic carbon monoxide fumes rests solely on you.** Installing a carbon monoxide/propane alarm is just the first step in protecting your family from toxic carbon monoxide poisoning. **The following symptoms are related to carbon monoxide poisoning and should be discussed with all members of the household:**
- Mild exposure:** Slight headache, nausea, vomiting, fatigue (often described as “flu-like” symptoms).
- Medium exposure:** Severe throbbing headaches, drowsiness, confusion, fast heart rate.
- Extreme exposure:** Unconsciousness, convulsions, cardio-respiratory failure, death.



The alarm is directly wired to the 12-volt electrical system, with continuous power being supplied by the recreational vehicle batteries. There is no 9-volt battery power supply. As a result, the alarm is always drawing a small amount of current from the recreation vehicle batteries. Although the current draw is slight, it could drain the batteries during extended storage periods. This condition is not likely to occur except during storage situations when the inverter cannot restore the battery charge. **If the battery cable is disconnected at the battery terminals, the combination alarm will not work.**

Be sure to read, understand and follow the owner's information from the manufacturer of the combination CO/propane alarm. This includes information regarding the limited life of the alarm.

Carbon monoxide (CO) is an insidious poison. It is a colorless, odorless and tasteless gas. Many cases of reported carbon monoxide poisoning indicate while victims are aware they are not well, they become so disoriented they are unable to save themselves by either exiting the recreational vehicle or calling for assistance. Young children and household pets may be the first affected.

Your combination carbon monoxide/propane alarm is designed to detect the toxic carbon monoxide fumes that result from incomplete combustion, such as those emitted from appliances, furnaces, fireplaces and auto exhaust.

A carbon monoxide/propane alarm is **NOT A SUBSTITUTE** for other combustible gas, fire or smoke alarms. This carbon monoxide alarm is designed to detect carbon monoxide gas from ANY source of combustion. It is not designed to detect smoke, fire or any other gas. Please note that there are hazards against which carbon monoxide detection may not be effective, such as natural gas leaks or explosions.

This alarm is designed to sense the presence of carbon monoxide/propane gas, however there are other combustible fumes or vapors that may be detected by the sensor including (but not limited to): acetone, alcohol, butane and gasoline.

These chemicals can be found in commonly used items such as deodorants, colognes, perfumes, adhesives, lacquer, kerosene, glues, wine, liquor, most cleaning agents and the propellants of aerosol cans.

High temperatures can activate glue and adhesive vapors. If you close up a recreational vehicle on a hot day, the chemicals used in its construction may be detected for months after the vehicle was constructed (for more information, refer to Sec. 2, Formaldehyde).



**Carbon monoxide/propane alarm (alarm may vary from model(s) shown)**

## SECTION 2: OCCUPANT SAFETY

### What you should do if the alarm sounds

#### **WARNING**

- Actuation of this detector indicates the presence of carbon monoxide which can kill you.
- Never turn the 12-volt battery disconnect control to the off position and disconnect the battery cable to silence an alarm. The alarm will automatically sense when the level of carbon monoxide in the air reaches below dangerous levels. You should stay outside the vehicle in fresh air until the alarm is silenced. When the alarm sounds, do not stand too close to the alarm. The sound produced by the alarm is loud because it is designed to wake a person in an emergency. Prolonged exposure to the alarm at a close distance may be harmful to your hearing.

1. Operate the RESET/SILENCE button.
2. Call your emergency services (fire department or 911).
3. Immediately move to fresh air (outdoors or by an open door or window).
4. Do not re-enter the premises or move away from the open door or window until the emergency service responders have arrived, the premises have been aired out, and your alarm remains in its normal condition.

If your alarm reactivates within a 24 hour period, repeat steps 1-4 and call a qualified appliance technician to investigate for sources of carbon monoxide from fuel burning equipment and appliances, and inspect for proper operation of this equipment. Make sure that motor vehicle(s) are not, and have not been, operating in an attached garage or adjacent to the recreation vehicle.

If problems are identified during this inspection, have the alarm serviced immediately. Note any combustion equipment not inspected by the technician and consult the manufacturer's instructions or contact the manufacturer directly for more information about carbon monoxide safety and this alarm.

#### **Alarm signals**

- Normal operation:** The LED will maintain a steady green light, indicating that the alarm is powered.
- CO alarm condition:** The red LED light will remain steady and the alarm will sound 4 "BEEPS" then silent for 5 seconds. These signals indicate immediate action is required.
- Propane gas alarm:** The red LED flash and the alarm will sound a steady tone. These signals indicate immediate action is required.
- Alarm malfunction/low battery:** The gas LED will remain off and the Operational/CO LED will alternate red/green and the alarm will sound once every 15 seconds.
- End of life alarm:** The LED will flash red/red, green/green and the alarm will "BEEP" every 25-30 seconds. The alarm should be immediately replaced.

#### **Maintenance**

Vacuum the alarm cover at least once a year. Clean the cover by hand using a cloth dampened in clean water. Dry with a soft cloth. Do not spray the front panel of the alarm with cleaning agents or waxes. This action may damage the sensor causing an alarm or cause the alarm to malfunction. Do not paint the face of the alarm.

**Testing the combination carbon monoxide/propane alarm**

 **WARNING**

Test the alarm operation after the RV has been in storage, before each trip and at least once per week during use.

The TEST/RESET button tests all ELECTRICAL functions of the alarm. The TEST/Mute switch is located on the front of the alarm. Press and hold the test button for 1 second. The alarm is working properly if the GREEN indicator light changes color to RED and the horn beeps 4 times. The Gas LED should also blink red.

 **NOTE:** Pressing the test button does not check the sensor operation. Refer to the carbon monoxide/propane alarm manufacturers user's manual provided with your recreation vehicle for additional information on testing the sensors.

Repair or replace the combination carbon monoxide/propane alarm when the alarm no longer functions. As with any electronic product, it has a limited life. Alarms that do not work cannot protect you.

 **NOTE:** The carbon monoxide/propane alarm manufacturer strongly recommends replacement of the detector five years after the date of purchase.

**FORMALDEHYDE**

Some components in the recreation vehicle contain formaldehyde-based adhesives that may release formaldehyde fumes into the air for an unknown period of time. Individuals who are allergic to formaldehyde gas fumes may experience irritation to eyes, ears, nose and throat. Indoor air quality may also be affected by leaving your vehicle closed for a period of time.

To aid in dissipation, ventilate the recreation vehicle by opening all windows and circulate the air with a fan.

This label is located inside the vehicle near the entry door. **The label should be left permanently affixed to the recreation vehicle.**

 **CAUTION**

Product in this vehicle may contain formaldehyde, which may be an irritant to you. You may experience a greater concentration during high humidity and temperatures. Ventilate to remove. Consult your owner's manual for additional information.

DO NOT REMOVE THIS LABEL

**EXTENDED OR FULL TIME USAGE**

Your new recreation vehicle has been built for enjoyment in a recreational manner. It is not intended for use as full-time quarters or a permanent residence. Continuous living in your vehicle could cause accelerated wear and damage to the various components.

## **SECTION 2: OCCUPANT SAFETY**



### **CAUTION**

Continuous or permanent living in your recreation vehicle may affect your warranty coverage and may void the “Limited Warranty” applicable to your vehicle.

## **COLD WEATHER USAGE**

When used in freezing or below freezing temperatures, the precautions should be taken:

- Fresh water and drainage systems - preparations to avoid freeze-ups.
- Propane gas (if so equipped) and sufficient power is needed for protection from possible freeze-ups on the propane gas regulator. Keep in mind that more frequent furnace operation will substantially increase battery draw and propane gas use.
- During cool weather usage, ventilation or addition of a dehumidifier may be required to reduce condensation.
- Check outside extrusions on compartment doors, locks, slide outs, windows, vents, etc., for frozen moisture before operating to avoid damage to parts.

## **CONDENSATION**



### **WARNING**

Condensation may cause dampness, mildew, mold, staining and, if allowed to continue, it may result in damage to the recreation vehicle (damage caused by condensation is not warrantable). It can also lead to mold or mildew issues, which could be a health hazard.

Condensation is a natural phenomenon. The amount of condensation will vary with climate conditions, particularly the relative humidity. Condensation occurs because there is water vapor present in the air. When the temperature reaches the “dew point” the water vapor in the air condenses and changes to a liquid form.

Proper ventilation or the use of a dehumidifier (customer supplied) will assist in controlling the condensation. Suggestions to eliminate warm moist air:

- Crack open windows and roof vents to allow warm moist air to escape.
- Open the bath roof vent (if so equipped) approximately ½” when showering.
- Use the range hood fan (if so equipped) when cooking or washing dishes.
- Avoid hanging wet towels (or clothes) inside the recreation vehicle to dry.
- If found in cabinets or closets, open the doors slightly to provide ventilation.

### **TOW VEHICLE**

If you plan to tow your recreation vehicle with a tow vehicle you already own, or if you plan to purchase a new one, make sure the Gross Vehicle Weight Rating (GVWR) or your recreation vehicle does not exceed your tow vehicles towing rating.

Ask your automotive dealer how to obtain a copy of information that deals with towing considerations, with or without an optional vehicle tow package.

### **VEHICLE LABELS**

Decals and data plates used throughout the recreation vehicle aid in its safe and efficient operation; others give service instructions. Read all decals, data and instruction plates before operating your recreation vehicle. Any decal, data or instruction plate painted over, damaged or removed should be replaced.

Keep a record of the 17-digit chassis vehicle identification number (VIN), the 8-digit serial number, and your license number in the event theft or vandalism requires you to supply this information to the authorities.

### **Weight Terms**

#### **WARNING**

- The factory-installed weight labels are specific to the recreation vehicle for which they are supplied and are not interchangeable. Do not remove these labels from your vehicle. If labels are missing contact your dealer or Customer Service for replacements.
- Do not exceed any applicable weight ratings. Doing so could damage your RV or tow vehicle and adversely affect handling and braking characteristics.**

**GAWR - Gross Axle Weight Rating:** The value specified by the vehicle manufacturer as the load-carrying capacity of a single axle system, as measured at the tire-to-ground interfaces. This is the total weight a given axle is capable of carrying.

**GCWR - Gross Combined Weight Rating:** The value specified by the trailer manufacturer as the maximum allowable loaded weight of the trailer including full propane cylinders, a full load of water, and full generator fuel if applicable.

**GVWR - Gross Vehicle Weight Rating:** The value specified by the manufacturer as the maximum permissible weight of the fully loaded trailer.

**OCCC - Occupant And Cargo Carrying Capacity:** Is equal to the GVWR of the trailer, minus the weight of the trailer (as completed at the factory) minus the weight of all personal cargo, and, if applicable, minus the weight of a full tank (or tanks) of propane and the full weight of potable water, including the water heater (if so equipped). Additions to or other changes made to the trailer after it left the factory will affect (reduce) the OCCC.

**UVW - Unloaded Vehicle Weight:** The weight of the trailer as manufactured at the factory with the weight of a full tank (or tanks) of propane.

### **Weight and Capacity Labels**

The following labels are typically located on the roadside front corner of the RV. An additional Occupant & Cargo Carrying Capacity label is also located on the inward surface of the entry door.



**LOADING YOUR RECREATION VEHICLE**

**⚠ WARNING**

- ❑ **Never load the RV in excess of the GAWR for either axle. Overloading your RV may result in adverse handling characteristics and damage to the RV.**
- ❑ **DO NOT EXCEED YOUR GVWR!** This means you should weigh your RV as loaded for your normal travel to determine the actual weight. If you exceed the GVWR, you **MUST** remove items from the RV, or drain liquids, then re-weigh the vehicle to ensure you have achieved a safe weight. **Do not travel with full grey/black holding tanks.** This not only wastes gas but, depending upon the location of the grey or black holding tanks, can affect handling characteristics.

Store and secure all loose items inside the RV before traveling. Overlooked items can become dangerous projectiles during a sudden stop.

Distribute cargo side-to-side so the weight on each tire does not exceed one-half of the GAWR for either axle. Make sure any tie down straps (if so equipped) on appliances or furniture are secure. Load heavy objects on the floor, or as low as possible.

**⚠ WARNING**

- ❑ Your recreation vehicle's load capacity is designated by weight, not by volume, so you cannot necessarily use all available space when loading the vehicle. Do not exceed your GVWR and ensure you are loading the vehicle as evenly as you can for the best possible handling. Ensure heavy items are secured so they do not shift during travel.
- ❑ Store items in areas designated for storage. **Do not store anything in the areas reserved for the converter, electrical panels or the furnace or water heater, etc.**

**CARGO CARRYING ACCESSORY RECEIVER (IF SO EQUIPPED)**

**⚠ WARNING**

**Receiver is for cargo carrying accessories ONLY. DO NOT tow any trailer or other vehicle. Load Limit for this receiver is 300 lbs Maximum.** Use for towing or exceeding load limit will void the warranty. Failure to follow the instructions can cause the carrier to collapse or items to fall which could cause an accident resulting in death or serious injury.

## SECTION 3: PRE-TRAVEL INFORMATION

### ***REAR BUMPER***

The rear bumper of your RV is not designed to carry cargo. Items that extend beyond the bumper OR weigh over 100 lbs. (45kg) will place undo strain on the bumper. The 100 lb. bumper capacity includes the weight of the spare tire (if so equipped).

#### **CAUTION**

Do not add items to the recreation vehicle rear bumper. Add-on items will eventually damage your bumper. Damage caused by such aftermarket equipment installation or improper loading voids the **Towable Limited Warranty**.



**NOTE:** Some items may fall within the given weight range, (IE: bike racks) however, they can still cause damage. In addition, extra weight behind the axle may reduce the hitch weigh which can adversely affect handling.

### ***FIFTH WHEEL PIN BOX (CUSTOMER SUPPLIED)***

Hitch selection affects the towing and handling characteristics of your recreation vehicle. There are many kinds of hitches available and assuring that you have the correct hitch installed is critical to a safe towing.

Ask your dealer about the proper class and type of hitch you need to purchase for your individual tow vehicle/RV combination. A fifth wheel requires a pin box hitch bolted directly to the floor of the truck box through the frame.

The hitch class rating based on the capacity that hitch has for towing and a weight classification. The weight classification is determined from the hitch's weight carrying capacity (the pin box weight on a fifth wheel). Before selecting a hitch, you must know your GVWR and pin box rating. **The rating of the hitch package purchased should be equal to or greater than the RV's GVWR and the pin box rating.**

#### **CAUTION**

Using an oversized or undersized hitch can cause damage to the RV frame. We (as your RV manufacturer) cannot be responsible for the tow vehicle suspension system. The final ball height after the tow vehicle/fifth wheel combination is completely hooked up is a factor that must be considered. To avoid overloading your trailer axles and minimize possible handling difficulties, your trailer should be level when hooked to your tow vehicle. Do not overload your tow vehicle.

Equipment that sometimes gives autos, trucks and sport utility vehicles a softer ride can accentuate swaying when pulling a RV; conversely, suspension that is too stiff will increase vibration, bounce and accelerate wear of your tow vehicle and RV combination.



**Your recreation vehicle manufacturer cannot be responsible for the suspension system of any tow vehicle. There are a variety of tow vehicle suspension systems available that will affect the pin box height, stability and levelness of a hooked up RV.** Make sure your dealer is aware of the tow vehicle you are using so a compatible hookup is achieved.

### **Fifth Wheel Pin Box**

The fifth wheel factory installed pin box is not interchangeable. Maintain the proper pin box weight on the hitch.

### **Fifth Wheel Pin Box Height**

There is no recommended hitch height for fifth wheels; usually the fifth wheel pin box is adjustable for variance in trucks and truck suspension systems.

Adjust the hitch assembly so the tow vehicle and the fifth wheel are essentially level. A high hitch will transfer weight behind the axles and cause the vehicle to fishtail.

A low hitch will transfer additional weight to the hitch. Refer to the hitch manufacturer instructions to adjust the weight distributing hitch to the proper height.

If you have additional questions, consult with your dealer. Make certain your Dealer is aware of the tow vehicle you are using so a compatible hookup is achieved.

### **Fifth Wheel Hitching Procedure**

The following procedure will help to assist you in securely hooking up your recreation vehicle to your tow vehicle.

1. Make sure the trailer wheels are blocked.
2. Make sure the hitch lever is in its open or “cocked” position unless it has been designed to open automatically. Adjust the fifth-wheel travel trailer pin to the proper height. Lower the tailgate, if applicable.
3. Back the truck so the hitch encircles the fifth-wheel/travel trailer pin.
4. A gentle contact of the hitch saddle against the pin will cause the mechanism to close.
5. Secure the hitch lever as specified by the manufacturer.
6. Put the truck in drive (DO NOT press on the accelerator) and ‘bump’ the hitch to make sure it is locked.
7. Be sure to raise the fifth-wheel landing gear all the way up.
8. Attach the breakaway switch cable to the tow vehicle.
9. Plug the wire harness/connector plug from the tow vehicle to the fifth wheel.
10. Remove the wheel chocks from the trailer wheels.

**Fifth wheel landing gear** can be operated manually. The fifth wheel landing gear must be fully retracted before moving or towing the RV to prevent damage.

## **WARNING**

**DO NOT USE THE FIFTH WHEEL LANDING GEAR TO SUPPORT THE TOW VEHICLE WEIGHT.** The fifth wheel landing gear is designed to bear the front loaded weight of the RV only.

## SECTION 3: PRE-TRAVEL INFORMATION

### **WIRE HARNESS/CONNECTOR PLUG**

A 7-way wire harness/connector plug is wired into your trailer to connect electrical power from the tow vehicle for travel. This supplies power to the RV brakes, taillights, clearance lights, turn signals, brake lights, etc. Wiring to operate your brakes must be the same size in both the tow vehicle and RV (the RV brake wiring is 12-gauge wire).

When attaching wires to your tow vehicle, tape all the connections for moisture protection.

White	1	Ground
Blue	2	Electric Brakes
Green	3	Running Lights
Black	4	Auxiliary +12V battery charge line
Red	5	Stop & left turn
Brown	6	Stop & right turn
Yellow	7	Back up Lights



7-way trailer plug  
car end, rear  
view



12V  
Circuit  
Tester

The connector plug may build up corrosion with extended use. It should be cleaned periodically to insure good electrical contact. Make sure the connector plug is kept clean and protected from road elements as you travel.



**NOTE:** A 12V circuit tester is recommended to verify the trailer connections.

### **WEIGHING YOUR TOW VEHICLE AND RV**

When the RV is fully loaded it should be weighed. The actual weight of the vehicle, all options, liquids, the hitch weight, and your personal cargo is important for you to know so you do not exceed the GVWR. Two important factors when loading your RV are total weight and balance.

It is imperative that you verify compliance within all applicable weight ratings. Overloading your RV will void the **Towable Limited Warranty** and the warranties of many component part manufacturers.

Periodically weigh your RV at a public scale to determine proper load distribution. To obtain the side-to-side weights, there needs to be enough space on either side of the scale to accommodate the RV being partially off the scale. **Keep in mind that individual scales will operate differently.**

**To weigh your tow vehicle and RV**

 **WARNING**

- Total weight of your tow vehicle and RV must not exceed the GCWR.** Do not assume that you can tow a RV that happens to be within the capacity of the tow vehicle hitch. By doing so, you may exceed the total GCWR of your tow vehicle and RV towing combination.
- It is important to redistribute the load to avoid component failure as well as to improve the handling characteristics of the vehicle and not void the **Towable Limited Warranty.**

Your RV must be weighed fully loaded (with food, clothing, fuel, water, propane, supplies, etc).

1. Weigh the RV including the tongue weight, while detached from the tow vehicle. This actual overall weight must be less than or equal to the GVWR for safe operation. If the overall weight is greater than the GVWR, some contents must be removed until the actual overall weight is less than or equal to GVWR.
2. Hitch the RV to your tow vehicle. Weigh the RV and the tow vehicle to determine the GCW. Make sure that this rating is less than or equal to the GCWR as specified by the manufacturer of your tow vehicle. If this overall weight is greater than the GCWR, some contents must be removed to bring the combination into compliance with the listed ratings.
3. Weigh the RV while attached to but excluding the tow vehicle. This will result in the actual weight that is exerted on all of the RV tires. This weight may be subtracted from the overall RV GVWR to determine the actual “tongue” weight.
4. With the RV still attached to the tow vehicle, weigh each wheel position separately to ensure each tire is not overloaded.

**To determine the wheel position weight**

5. Pull the RV onto the scale so only one tire is on the scale. Record the weight. Your RV must remain as level as possible on the scale (even though an axle or side is not physically on the scale).
6. To calculate the opposite side of the RV wheel position weight, subtract the first side’s weight from the weight determined in step #3.

If there is a difference in the weights on one side of the vehicle as compared to weights on the other side, components (tires, wheels, brakes, springs, etc.) on the heavier side could be overloaded, even though the total axle load is within the GAWR.

Once actual weights are obtained, compare them to the **Weight Information Label** weight ratings to ensure you are below the posted minimum ratings.

See the *Weight Terms and Loading Your RV* sections for important weight information.

### **SECTION 3: PRE-TRAVEL INFORMATION**

**Notes:**

**TOWING**

**⚠ WARNING**

- Your RV braking system is rated for operation at GVWR not GCWR.**
- Whenever possible, do not travel with waste in the holding tanks. Liquid or debris in the holding tank(s) may affect the towing characteristics and may result in property damage or personal injury.
- The propane cylinder(s) should be turned off when traveling. Most refrigerators will keep food cold or frozen for eight hours without running while you travel.

Your RV will travel safely and comfortably at highway speed limits. It will take longer than a passenger automobile to reach that speed. Allow more time to go around vehicles you are passing. Avoid situations that might require sudden momentum changes as the length of the tow vehicle/RV combination affects your ability to quickly cut back into traffic. Swerves and sharp turns, especially at high speeds, could result in loss of control of the tow vehicle/RV. Slow down in advance of dips, bumps and railroad tracks to reduce the jolting to your tow vehicle/RV combination. Proceed slowly and let the trailer tires pass over them before accelerating.

Adverse weather conditions and extremes in terrain may affect the performance and handling of your tow vehicle. Do not operate the tow vehicle cruise control on icy or extremely wet roads, winding roads, in heavy traffic or in any other traffic situation where a constant speed cannot be maintained.

When descending a long hill, drop down into a lower gear or range. Avoid conditions that require excessive and prolonged use of your brakes. Apply and release brakes at short intervals to allow them to cool. The tow vehicle transmission and engine will help in controlling downhill speed and can lengthen brake life. Use care when accelerating or decelerating on a slippery surface. Abrupt speed changes can cause skidding and loss of control.

Know the weight and size of your towing combination and observe any posted weight and clearance limits. The added height of roof air conditioners, TV antennas or floodlights may cause clearance problems around some tunnels, canopies and hanging signs.

When turning, the tires do not follow the path of your tow vehicle tires. The RV will make a tighter turn than the tow vehicle. Compensate for this action by carefully pulling the tow vehicle out into the intersection further than you would normally so that the RV clears the curb. When making a turn, check the road clearance and be aware of others. Swerves and sharp turns, especially at high speeds, could result in loss of control of the RV.

If your camping destination does not have pull through sites, pick a level site and back in carefully. Check to ensure there are no obstacles in your path and that you have plenty of vehicle clearance.

After the RV is in the desired location, set the tow vehicle parking brake. Block all RV wheels securely with wheel chocks to prevent it from rolling.

**RV Brake System**

Even though your RV is equipped with brakes designed for GVWR, proceed with caution until you become accustomed to your RV's stopping distance.

Driving through water deep enough to wet the brakes may affect stopping distance or cause the vehicle to pull to one side. Check the RV's brake operation in a safe area to be sure they have not been affected. **Never operate any vehicle if a difference in braking efficiency is noticeable.**

## SECTION 4: VEHICLE OPERATION

### Electric Brakes

# **WARNING**

Failure to maintain the brakes in proper working condition as specified in the operator's manual supplied by the axle OEM will cause property damage, personal injury and possibly death. Consult with your dealer for assistance.

**The electric brakes are designed to work with the tow vehicle brakes. To maintain proper braking performance, both the RV and tow vehicle brakes must be used together. Separate use of the braking systems will cause accelerated wear and damage.**

When your RV is new, it is impossible to adjust the brake shoes precisely. It takes approximately 1,000 miles and/or 50 medium to heavy stops to “burnish” fit or “seat” the shoes to the brake drum. After the initial break-in period your brake shoes must be adjusted accurately for best performance and increased durability.

#### **Braking system components include:**

- Tow vehicle battery
- Brake controller
- Wire harness/connector plug
- Trailer battery
- Breakaway switch

The tow vehicle battery is the primary source of power for your RV's electric brake operation. To ensure available power when needed, keep your tow vehicle battery and charging system working properly.

#### **Brake Controller (customer supplied)**

The brake controller should be installed in the tow vehicle to work in conjunction with the RV electric brakes. Consult with your dealer or the brake controller OEM to decide what is right for your towing combination.

#### **Travel Trailer Breakaway Switch**

# **CAUTION**

**NEVER** use the breakaway switch and trailer brake system as a parking brake. Doing so would create a high amp draw on the battery and converter. This can cause damage to wiring, connectors and the breakaway switch.

The breakaway switch is a crucial part of the RV braking system. Located on the travel trailer A-frame (or beside the fifth wheel pinbox), this switch will apply the trailer brakes if the trailer becomes detached from the tow vehicle. Attach the breakaway switch lanyard to a permanent part of the tow vehicle (on a travel trailer do not attach it to the hitch ball or similar removable parts) when hitching the trailer. If the RV becomes detached from the tow vehicle, the pull pin will be pulled from the switch. This automatically causes the switch to “close” and activates the RV brakes. **A battery (customer supplied) must be installed to activate the breakaway switch.**

### **Hydraulic Brakes (if so equipped)**

Your RV may be equipped with hydraulic surge brakes that operate automatically as the tow vehicle's brakes are applied. When speed is decreased and brakes are applied, the weight of the trailer moving forward creates a reaction, which causes the brake fluid inside the wheel cylinder to activate the brake shoes against the drum.

As a result of this design, backing the RV uphill may activate the surge brake system making it difficult to continue in reverse. To aid in backing up the RV:

1. Prior to backing up a slope or through soft ground, pull the recreation vehicle forward slightly to assure that the actuator socket is in the forward position.
2. Move the lever on the side of the actuator downward from the "towing position" along the curved slot in the actuator frame to the "backup position." The slot has a notch at the bottom of its travel. Push the lever down to engage the locking notch.
3. The RV will now back up. This lever will slide into the correct position when pulling forward.

It is extremely important to keep the master cylinder full at all times. An empty cylinder invites moisture.

### **Disc Brakes (if so equipped)**

If your RV is equipped with disc brakes, see the manufacturer's owner's manual for detailed safety and maintenance information.

## **TOWING BEHIND YOUR RV**

### **WARNING**

If you do not have a **Jayco factory installed hitch receiver**, towing items behind your Jayco RV, or overloading the rear, will void the warranty and may result in: damage to the RV or add-on items, towing difficulties, property damage and/or personal injury.

**NOTE: IF YOU DO NOT HAVE A JAYCO FACTORY INSTALLED HITCH RECEIVER, DO NOT TOW ANYTHING BEHIND YOUR RV. THE RV FRAME AND BUMPER ARE NOT DESIGNED FOR TOWING.**

**NOTE:** A hitch equipped for trailer towing will have tabs to hang the safety chains and there will be a bracket for the trailer wiring plug. There should also be a label on the hitch stating maximum towing capacity.

***FACTORY INSTALLED HITCH RECEIVER (IF SO EQUIPPED)***

**⚠ WARNING**

- ❑ **If you do not have a Jayco factory installed hitch receiver, towing items behind your Jayco RV, overloading the rear, or failure to adhere to the specified weight capacities will void the warranty and may result in: damage to the RV or add-on items, towing difficulties, property damage and/or personal injury.**
- ❑ **The hitch receiver installed on your RV is a weight carrying hitch only. Do not use weight distribution bars or equipment when towing. Using weight distribution bars or equipment with the hitch receiver will void the warranty and may cause damage that could lead to adverse trailer combination towing and handling, loss of control or an accident resulting in death or serious injury.**



**NOTE: IF YOU DO NOT HAVE A JAYCO FACTORY INSTALLED HITCH RECEIVER, DO NOT TOW ANYTHING BEHIND YOUR RV. THE RV FRAME AND BUMPER ARE NOT DESIGNED FOR TOWING.**

**Additional Towing - Multiple Trailer Combinations (if so equipped)**

If your RV (applies to limited fifth wheel models only) is equipped with a factory installed hitch receiver, you have the ability to tow an additional boat or other watercraft trailer behind your RV.

The hitch receiver may be used as a weight carrying hitch to tow a boat or other watercraft trailer. Do not use a bar longer than 10-inches (254 mm). The maximum length of the draw bar is from the center of the fastening pin to the center of the ball. The maximum trailer tow rating of the fifth wheel hitch is 3,000 Lbs. (1361 kg.) with a maximum tongue weight of 300 Lbs. (136 kg.).

The receiver may be also used for attaching a cargo basket/ carrier for other items. Ensure the cargo carrier is properly attached to the hitch receiver and all cargo is properly secured in place. The cargo weight carrying capacity includes the weight of the cargo carrier. The maximum total weight when used to carry cargo is 300 Lbs. (136 kg.).

Be sure the trailer being towed by your RV is properly equipped with brakes. Contact your tow vehicle dealer or manufacturer for assistance in determining whether a separate braking system is recommended and what limits there are for towing multiple trailer combinations. Check the state or province where your tow vehicle and RV are registered as well as any state or province where travel is planned in the U.S. and/ or Canada for brake requirements and regulations.



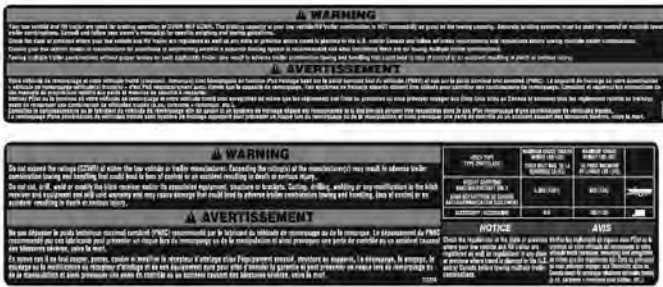

These labels have been placed on the hitch receiver and on the rear bumper of your RV. Be sure to read, understand and follow the information on them.

**Second Trailer Hitching Procedure**

The following procedure will help to assist you in securely hooking up the second trailer to your RV.

- Make sure the (second) trailer wheels are blocked.
- Turn the tongue jack crank to raise the trailer tongue above the hitch ball.
- Open the coupler latch on the trailer hitch.
- Back the tow vehicle/ fifth wheel combination to the proper position.
- Turn the (second) trailer tongue jack crank to lower the coupler onto the hitch ball.
- Close the coupler latch after it is completely seated.
- Remove the dolly wheel or platform (if so equipped) and retract the tongue jack to its maximum height.
- Attach the breakaway cable to the hitch receiver on the RV fifth wheel.
- Attach the safety chains. See *Safety Chains* for additional information.
- Plug in the wire harness/connector.
- Walk around the RV and the second trailer making sure all exterior lights are working correctly.
- Remove the trailer wheel blocks.

**Wire Harness/Connector Plug**

A 4-way wire harness/connector plug is wired into your RV to connect electrical power from the RV to the second trailer for travel. This supplies power to the tail lights, clearance lights, turn signals, brake lights, etc. The 4-way wire harness/connector is not wired for operating electric brakes.

The connector plug may build up corrosion with extended use and should be cleaned periodically to insure good electrical contact. Make sure the connector plug is kept clean and protected from road elements as you travel.

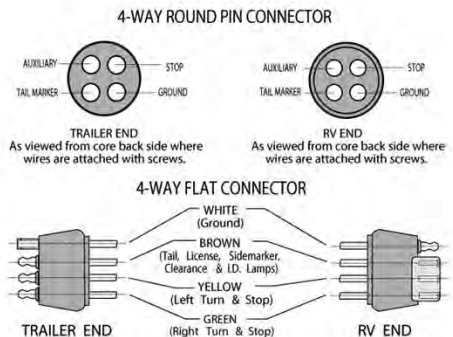

## SECTION 4: VEHICLE OPERATION

### ***ENTRANCE DOOR STEP(S)***

Make sure your entrance step is fully extended before exiting the vehicle, and retracted prior to towing.

#### **Lubricating the step mechanism**

Carefully clean the area around the pivot points (the rivets involved in the motion of the mechanism). Lubricate these pivot points with an automotive grade, non-staining lubricant every 30 to 60 days.

Wipe any excess lubricant off of the step and then clean the entire step after lubricating.

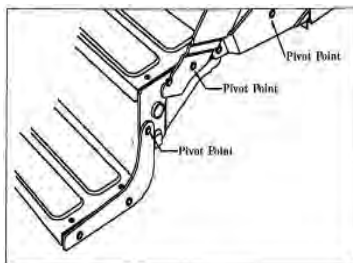

#### **Step Light**

Your RV may be equipped with a switch located on the skirt (in front of the steps) which operates a light located under the step assembly.

### ***STOWABLE ENTRANCE DOOR STEP (IF SO EQUIPPED)***

#### **⚠ CAUTION**

- Do not try to lift the steps while the door is closed. This may cause damage to the steps and the door.
- When returning steps to the stored position: adjustable feet may have to be retracted to fit inside the door opening.
- Make sure people and pets are clear of the area when rotating the steps down to the ground or raising them for storage.

#### **⚠ WARNING**

- Maximum Weight Capacity 500 lbs.
- Maintain hold of the steps until lowered all the way to the ground.
- Prior to use, legs must be adjusted properly to ensure the step is level.
- Ensure that both latches are engaged when the steps are stored.
- Failure to follow these instructions could lead to damage to the unit or serious injury.

Your RV may be equipped with one (or two) sets of the Stowable Entrance Steps. With these steps, there is no accessible steps mounted on the exterior of the RV. They are a one piece solid (3 or 4 step) assembly that latches inside the doorway of the RV. The steps rotate down and out of the doorway, and include two adjustable feet to provide stability while parked on rough terrain. The step assembly weighs 17 lbs. and has a weight capacity of 500 lbs.



**NOTE:** Certain models may have dual gas struts built into the step mechanism make the steps very easy to raise and lower in place.

### Step operation

1. Open the entrance/screen door all the way.
2. Twist the locking handle to release the steps from the locked position on the door frame (A).
3. Lower the step assembly to the ground (B).
4. Adjust the feet to stabilize the steps (C).



### Step storage

5. Fold the handrail at the door out of the way or remove the optional step handrail (if so equipped).
6. Retract adjustable feet (C) if necessary to fit inside the doorway.
7. Lift the steps and rotate up into the doorway.
8. Steps will automatically latch into brackets on each side of the door frame as they are lifted in place.
9. Close the entrance/screen door

## ENTRANCE DOOR

Always hold onto the entrance door when opening or closing it. Damage caused because you failed to do so is not covered by the **Limited Warranty**.

### CAUTION

Make sure the entrance door is completely closed and locked when traveling. Locking the door helps prevent it from opening unintentionally and keeps intruders from your recreation vehicle.

The entrance screen door may be equipped with a slide panel that allows access to the entrance door handle and locks. The entrance door may also be equipped with both a regular door lock and a dead bolt lock.

### Keys

Several keys are provided when you purchase your vehicle. Most keys have an individual key number stamped on the plate. Record these key numbers and keep the information in a safe place. You can order a key blank from your dealer to have duplicate keys made. If you lose the keys, contact your dealer or a locksmith for assistance.



**NOTE:** Locks on entrance and baggage doors need biannual lubrication using a light coat of silicone spray. Conditions such as rain, salt, dust and pollution may increase the maintenance needs.

## **SECTION 4: VEHICLE OPERATION**

### **REAR BACKUP CAMERA PREP**

Your recreation vehicle has been pre-wired to allow for installation of a (customer supplied and customer installed) rear backup camera and a customer installed (or dealer installed) camera ON/OFF switch so the backup camera can be used as an observation/security camera.

Depending on your RV model, a camera accessory power wire is pre-routed at the factory from the rear camera, to the bedroom or the command center panel inside the entrance door. An ON/OFF switch would be installed (by the customer or the dealer) either in the bedroom or in or near the command center panel. The camera accessory power wire would be attached to this switch. The camera monitor is then plugged into the camera charge center in the bedroom or near the command center panel to be used for observation or security purposes.

Certain models may have a pre-installed power switch for the camera located in an exterior compartment. (e.g. battery storage or utility center bay) Your dealer can tell you if your model comes with a switch pre-installed.

An instruction sheet is included with your RV detailing the installation of the backup camera, and the camera power switch. It also explains where to find the camera accessory power wire in your particular model RV. This instruction sheet is included in your Warranty Packet.

### **CAMPSITE HOOK-UP**

- Refer to *Electrical Systems* section before connecting the shore line power cord (when using full hook-up) OR before starting the generator (if so equipped) or operating the vehicle on 12-volt power when dry camping.
- Refer to *Fuel & LP System* section before using the LP system. Open the LP gas tank valve (if so equipped) slowly. There may be air in the lines and five to thirty seconds of time is needed to bleed air before LP vapor fills the lines.
- Refer to *Plumbing Systems* section before connecting the fresh water supply or turning ON the water pump or water heater.
- When using full hook-up, connect the sewer hose to the campsite sewer hook-up.
- If applicable, start the refrigerator and the cooling or heating system.



**NOTE:** For extended dry camping, management of all your resources is essential. Check your battery levels and conserve battery power, use it sparingly

### **LCI 3.0 LEVELING SYSTEM (IF SO EQUIPPED)**

The LCI Ground Control 3.0 is an electric 4 or 6 point automatic leveling control. The system utilizes one main control board and a separate waterproof remote level sensor to measure and manage level point, and can be operated from several user interface devices including:

- **Auto Leveling Control Touch Pad** - Mounted outside the RV within view of the hitch.
- **MyRV® OneControl Touch Panel (OCTP)** - Mounted on a wall inside the living space of the RV.
- **MyRV® OneControl Leveling App** - App available from Google Play or iTunes for Apple or Android devices.
- **Linc® Remote Control** - Optional (located inside the entrance door).

## ⚠ WARNING

**Failure to act in accordance with the following warnings may result in serious personal injury or death!**

- ❑ **Never use the auto leveling system to lift the RV off the ground.** Lifting the RV so the wheels are not touching the ground will create an unstable and unsafe condition.
- ❑ The leveling system is designed *only* for leveling the unit and should *never* be used to provide service **for any reason** under the RV such as changing tires or servicing the system. It is **not** recommended that you change a tire yourself.
- ❑ Park the RV on level, solid ground.
- ❑ Ensure all jack locations are clear of debris, obstructions or depressions.
- ❑ People and pets should be clear of the RV while system is in operation.
- ❑ Battery should be fully charged, or the RV plugged into shore power prior to operating the leveling system.
- ❑ Keep hands and body parts clear of fluid leaks. Hydraulic fluid leaks may be under high pressure and can cause serious skin-penetrating injuries.
- ❑ Using the LCI Level-Up® system in a manner other than its intended use will void the limited warranty and may cause serious injury, death, or damage to the RV or personal property.

### Auto Leveling Control Touch Pad

**A** - Red/Green LED indicates system status

**B** - Up Arrow extends front jacks (landing gear)

**C** - Down Arrow retracts front jacks (landing gear)

**D** - Auto Level button places system in the auto level mode

**E** - Hitch Height button initiates the Hitch Recognition feature

**F** - Retract All button puts leveling system in full retract mode.

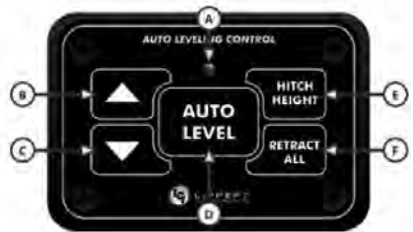

**NOTE:** Pressing both the arrow buttons simultaneously turns on the touchpad. Touchpad will time out after 7 minutes of non-use.

### Auto Level Touchpad LED Indicator status

**OFF** - Touch pad is locked

**Solid Green** - Touch pad is active

**Blinking Green** - Jacks are moving

**Solid Red** - Low battery

**Blinking Red** - Error

The OneControl touch screen or Leveling App will show the specific error.

Refer to troubleshooting section of the LCI Ground Control 3.0 manual to clear the error.

## **SECTION 4: VEHICLE OPERATION**



**NOTE:** Refer to the Lippert Ground Control 3.0 manual included in our warranty packet for complete instructions on the following procedures.

### **Auto Leveling Touch Pad**

#### **Unhitching the RV**

1. Before unhitching from the tow vehicle, ensure the RV is parked on a level surface and tires are chocked.
2. Extend the inner legs of both landing gear (front jacks) to within 4”- 5” of the ground by pulling on the quick release pins.
3. Turn on the touchpad by pressing both arrow buttons simultaneously. LED illuminates solid green.
4. Press the UP arrow button to extend the front jacks to lift the front of the RV taking weight off the hitch.
5. Uncouple the RV connection to the tow vehicle. Pull tow vehicle away.

#### **Auto Leveling**



**NOTE:** When the leveling cycle has started, it is important there is no movement inside the RV until leveling is complete. Failure to remain still during leveling could affect the performance of the leveling system.

1. Turn on the touchpad.
2. LED will light up solid green.
3. Select AUTO LEVEL and the auto leveling process begins. Front of the RV will seek a position near level. Rear jacks will be grounded (on 4 point system). Side to side leveling will begin.
4. Each jack will perform a final grounding touch.



**NOTE:** On a 6 point system the 2 middle jacks will be grounded to stabilize the trailer. The 2 middle jacks do not level the RV



**NOTE:** If the AUTO LEVEL sequence does not perform as described above, place the system in manual mode and test that the jacks operate correctly by using the OneControl touch panel inside the RV.

### OneControl Touch Panel

1. Press the button at the bottom of the touch panel to power up the display.
2. Select MyRV Control Panel from the menu listing on the screen.
3. Then select the Leveler icon.

The following functions can be operated using the OneControl Touch Panel inside the RV. Refer to the Lippert Ground Control 3.0 manual for complete instructions.

- Standard Mode and Menu
- Basic Jack operation
- Unhitching instructions
- Auto Leveling
- Hitch Recognition



**OneControl Touch Panel**

### OneControl App: (for your phone or tablet)

1. Download the OneControl App for your device from Google Play Store or iTunes.
2. To access the OneControl App, ensure there is power to the RV's wireless network hub.
3. Navigate to the device's Wi-Fi settings (on the phone, tablet, etc). Turn the wireless feature on and connect to the MyRV wireless network.
4. A password will be required to access the network. The password is found on the RV's wireless hub (8 capital alpha characters).
5. Open the OneControl App on the phone or tablet.
6. The App will request the user to "Agree" with a license agreement, connect to the MyRV system by entering the PIN (default is 1,2,3,4 for OneControl Touch Panel). Then it will prompt you to create a new PIN and then re-enter the new PIN.



**NOTE:** The PIN is not needed or asked for if the tablet is attached to the docking station and connected to the USB cable inside the RV.

7. The App will now display all functions. Choose Leveler. The following functions can be operated using the OneControl App. Refer to the Ground Control 3.0 manual for complete instructions.

- Standard Mode and Menu
- Basic Jack operation
- Unhitching Instructions
- Auto Leveling

## SECTION 4: VEHICLE OPERATION

### Linc Remote Control

#### Configuring the remote to sync with the OneControl Touch panel:

- Press the chrome button on the bottom of the remote to turn it on. Enter the PIN (default is 0,0,0,0). The PIN can be changed after entering the default PIN. A menu will appear, choose Leveler from that menu.
- Turn the OneControl Touch Panel ON inside the RV.
- At the top of the Touch Panel screen press the “CONNECTED” icon quickly 6 times.
- A GEAR icon will appear at the top of the screen that says “OPTIONS”. Press this GEAR icon. Screen display changes to “Select Operation” with arrows on the left side of the screen. Use to arrows on left side of screen. Scroll to “WIRELESS CONFIG”.
- Press the ENTER button at the bottom of the screen.
- The screen will display “Wireless Configuration Press any Linc button to sync”.
- Press any button on the remote control while in Leveler mode and the remote will be connected.



Linc Remote

Pressing the ABORT button on the touch screen will cancel the configuration sequence.

The following functions can be operated using the Linc Remote Control. Refer to the Lippert Ground Control 3.0 manual for complete instructions.

- Basic Jack operation
- Unhitching Instructions
- Auto Leveling

### Troubleshooting

Refer to the Lippert Ground Control 3.0 manual for troubleshooting information which includes the following:

- OneControl Touch Panel Error Codes
- Special Jack Error Codes on the OneControl Touch Panel
- How to manually override the jack motor
- Setting Zero Point Calibration
- Zero point is the programmed point that the RV will return to each time the Auto Level feature is used. Zero Point is only available on the OneControl Touch Panel.
- Preventative Maintenance tips

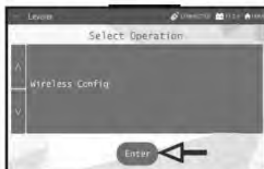

OneControl Touch Panel



**STABILIZER JACKS**

**⚠ WARNING**

**DO NOT USE THE STABILIZER JACKS TO LEVEL THE RV.**

It is important to remember that the stabilizer jacks are to be used only for support while occupying and moving around the RV. They are not designed to support the weight of the RV.

**The stabilizer jacks must be fully retracted before moving or towing the RV to prevent stabilizer jack damage.**

Each stabilizer jack can be individually adjusted to stabilize the RV for use.

When setting up on soft ground, you may wish to place a wood pad or the equivalent under each stabilizer jack foot to help keep the jack from sinking into the ground.

**Manual Stabilizer Jacks (if so equipped)**

1. To lower each jack, insert the jack crank onto the applicable stabilizer jackshaft.
2. Turn the crank clockwise to lower each leg until it contacts the ground and stabilizes the RV.

To raise each jack, insert the jack crank onto the applicable stabilizer jack shaft and turn the crank counter-clockwise.

**Electric Stabilizer Jacks (if so equipped)**

Control switches for the stabilizer jacks are typically located on the (door) side of the unit above the stabilizer jack(s).

To lower each jack, press the control switch until each leg contacts the ground and stabilizes the unit.

To raise the jack, press the control switch until the jack is returned to the retracted position.

**Manual Override**

The electric stabilizer jacks may have a built in manual override system. The override coupler is located on the end of the stabilizer jack opposite the electric motor. One of the wire motor leads must be disconnected to prevent back loading the motor and causing more damage.

**Disconnect the battery from the system prior to manual operation.**

**Operation:** Insert the 1/2" diameter crank handle inside the coupler. The slot in the end of the crank handle accommodates the pin inside the coupler to allow manual extension/retraction of the stabilizer jack. Rotate the handle clockwise to retract and counter clockwise to extend the jack.



**NOTE:** The gears can be stripped out if the stab jack is manually retracted/extended to its fullest extent and the operator continues to rotate the manual override.

## **SECTION 4: VEHICLE OPERATION**

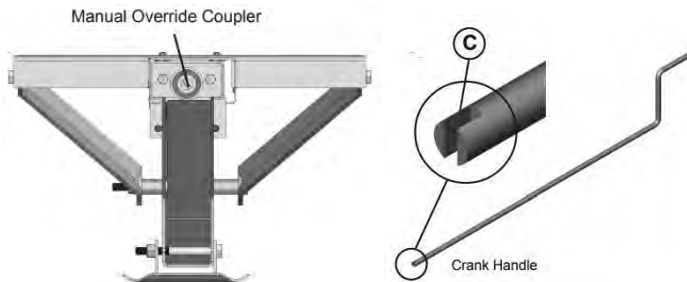

### ***EMERGENCY STOPPING***

Always carry road flares or reflective warning signs. Pull off the roadway as far as possible for emergency stopping. Turn ON your vehicle hazard warning flashers. If traveling at night, use three red warning indicators such as flares, reflectors or lanterns as required by the Uniform Vehicle Code and Model Traffic Ordinance as follows:

1. Place the first warning indicator on the traffic side of the recreation vehicle, directed at the nearest approaching traffic.
2. Place the second warning indicator 100 feet behind the recreation vehicle in the center of the lane and toward approaching traffic.

Place the third warning indicator 100 feet in front of the recreation vehicle in the center of the lane and away from the traffic approaching from behind.



**NOTE:** Curves and/or hills may affect the safe placement of warning indicators.

### **⚠ WARNING**

For personal safety, always stand off the road and out of the way of traffic.

### ***EMERGENCY TOWING***

### **⚠ WARNING**

Never allow anyone to go under the recreation vehicle while it is being lifted and/or being towed.

If your recreational vehicle needs to be towed, please contact an emergency road service provider or a qualified service facility for assistance.

### **WHEEL LUGS**

After your first trip, check the wheel lug torque periodically for safety. Check the wheel lugs after winter storage, after a wheel removal, before starting a trip or following extensive braking:

1. Use the correct star pattern sequence to attach the recreation vehicle wheels.
2. Start all nuts by hand to prevent cross threading.
3. Tighten the nuts in the sequence shown.
4. Lug nuts should be tightened in two stages. Lugs should be started by hand, then torqued to intermediate values (Stage 1) on the chart then torqued according to the final torque values on the chart. Refer to the Wheel Lug Nut Diagram below.



**NOTE:** The proper method of tightening wheel lug nuts is with a properly calibrated torque wrench and socket, not with an impact wrench or by hand. Do not use a 4-way lug wrench or any other type of wrench that does not measure the actual pressure applied to the lug nut. Lug nuts should be tightened according to the proper lug pattern on your wheels. Refer to the Wheel Lug Nut Diagram below.

### **⚠ WARNING**

- Check and tighten wheel lug nuts regularly to make sure they did not loosen during travel. Wheel lug nuts must be applied and maintained at the proper torque levels to prevent loose wheels, broken studs and possible separation of the wheel(s) from your recreation vehicle. The lug nuts on the wheels of your recreation vehicle must be maintained according to listed torque values (see **Wheel Lug Nut Torque Chart.**) Over-torqued and/or under-torqued wheels may result in component failure.
- Wheels should ***ALWAYS*** be mounted and properly torqued by a qualified service technician using the proper tools.
- Failure to maintain proper torque of the wheel lug nuts could lead to separation of the tire and wheel while driving, possibly resulting in property damage or personal injury.**

### **Wheel Lug Nut Diagrams**

Because of the importance of having proper torque on the wheel lug nuts, you should always have the wheels mounted and properly torqued by a qualified technician using the proper tools.

## SECTION 4: VEHICLE OPERATION



**4 Lug Nuts**



**5 Lug Nuts**



**6 Lug Nuts**



**8 Lug Nuts**

**Criss cross "star" patterns, as shown, must be followed during tightening sequence. A Digital or Dial Torque Wrench is recommended.**

Also applies to any service involving wheel or lug removal, during the life of the recreational vehicle.

### Wheel Lug Nut Torque Values

Lug Nuts	Stud Size GR 8	Rim Size	Rim Type	Stage 1 Torque Values <b>Start lug nuts with fingers</b>	Final Torque Values
4-Lugs	1/2"- 20	12"	Steel/Alum	45 ft lbs	70 ft lbs
5-Lugs	1/2"- 20	12"	Steel/Alum	45 ft lbs	70 ft lbs
5-Lugs	1/2"-20	13"	Steel/Alum	45ft lbs	70 ft lbs
5-Lugs	1/2"- 20	14"	Steel/Alum	65 ft lbs	120 ft lbs
5-Lugs	1/2"- 20	15"	Steel/Alum	65 ft lbs	120 ft lbs
6-Lugs	1/2"- 20	15"	Steel/Alum	65 ft lbs	120 ft lbs
6-Lugs	1/2"- 20	16"	Steel/Alum	65 ft lbs	120 ft lbs
8-Lugs	1/2"- 20	16"	Steel/Alum	65 ft lbs	120 ft lbs
8-Lugs	9/16" - 18	16"	Steel/Alum	65 ft lbs	120 ft lbs

1. Prior to travel and after excessive braking, wheel lug nuts should be checked for torque. Torque readings must fall within the Final Torque Values in chart above.
2. Torque specifications should be checked using a proper torque wrench.
3. If the torque falls below the Final Torque Values, additional torque is required.
4. Check and re-torque lug nuts at 10 miles (16 Km), 25 miles (40 Km) and 50 miles (80 Km) and again periodically during travel. Refer to diagrams above for proper lug pattern and Final Torque Values. Thereafter check and maintain torque according to the Final Torque Values in the chart above.

**Failure to follow these instructions may result in wheel loss, an accident, or loss of control, resulting in death or serious injury.**

### Lug Nut Pattern and Warning Label

The following labels showing the proper lug nut tightening pattern and a warning label are located on the driver side of the A frame hitch on travel trailers, and on the driver side of the pinbox on fifth wheel units. Lug pattern label will vary according to number of wheel lugs.

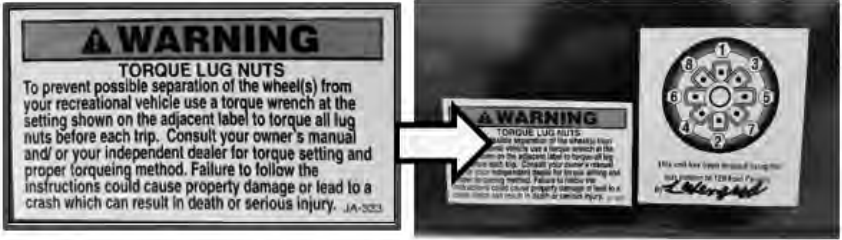

**Lug nut torque pattern and warning label**

**Torque Wrench Usage**

1. Tools should be maintained, in good condition, and stored appropriately.
  - Avoid dropping or sliding a torque wrench. Dropping it can cause the instrument to lose reliable calibration.
  - *Damaged tools must not be used and must be removed from service for evaluation and either reported and re-calibrated or replaced.*
2. Do not use accessories or handle extensions unless specifically allowed by the torque wrench manufacturer.
3. Do not use the torque wrench as the primary means of tightening or loosening fasteners.
4. Torque wrenches are length specific.
  - Grasp the torque wrench in the *center* of the handle when applying torque pressure.
  - Place one hand on top of the other when using two hands.
5. Apply torque in a slow, steady manner *in a downward direction* and avoid sudden “jerking” movements.
6. When the wrench signals (by clicking, beeping or lights) that a specific torque has been reached, stop immediately.

**TIRES**







Read and understand the following before taking your first trip in your RV.

Routine maintenance on your RV is important. **To insure your tires are operating safely, regular inspection of the tires and checking tire pressures is absolutely mandatory.**

Alignment, balance and bearing wear will affect tire wear. Make sure to look for cracking, bulging, uneven tread wear, etc.

## SECTION 4: VEHICLE OPERATION

### Tire Wear Diagnostic Chart

Wear Pattern		Cause	Action
	Center Wear	Over Inflation	Adjust pressure to particular load per tire catalog.
	Edge Wear	Under Inflation	Adjust pressure to particular load per tire catalog.
	Side Wear	Loss of camber or overloading	Make sure load doesn't exceed axle rating. Align at alignment shop.
	Toe Wear	Incorrect toe-in	Align at alignment shop.
	Cupping	Out-of balance	Check bearing adjustment and balance tires.
	Flat Spots	Wheel lockup & tire skidding	Avoid sudden stops when possible and adjust brakes.

## CAUTION

Tire wear should be checked frequently. Once a wear pattern becomes firmly established in a tire it is difficult to stop, even if the underlying cause is corrected.

### Tire Pressure

## DANGER

Failure to follow proper inflation guidelines may result in tire failure, which, under certain circumstances can cause loss of vehicle control or accidents that may result in property damage, bodily injury and/or death.

**You must follow the manufacturer's inflation guidelines for maximum load capacity; under-inflation is just as dangerous as over-inflation.**

Proper inflation should be monitored closely. Failure to do so could result in the overheating of a tire causing a blowout. Inflation pressure should be as recommended by the tire manufacturer or as the federal label for the recreation vehicle indicates.

When you are using your Recreational Vehicle, check inflation pressure weekly. Pressure should be checked when the tires are cold. During travel, tires heat up and pressure increases. **Do not bleed air from hot tires or your tires may then be under-inflated.**



**NOTE:** Cold tire inflation pressure is defined as a tire that has not been used for three or more hours, or has been driven less than one mile. Tire inflation pressure of a hot tire may show an increase of as much as 6 psi over a cold tire.

## **WARNING**

- It is recommended that the tire pressure be checked at the beginning of each trip to obtain the maximum life of the tire. Follow the instructions listed on the Federal Certification label, to determine the correct tire pressure. Under-inflation may cause tire failures and swaying resulting in loss of control, injury, death or property damage.

### **TOWABLE PRODUCTS ONLY**

- Towable recreation vehicles are equipped with special trailer (ST) tires that have a maximum speed rating of 65 MPH (104 km/h). **You should not exceed this speed rating.** Exceeding the tire speed rating may result in tire failure, which could lead to an accident causing serious injury or death.

## ***CHANGING A TIRE***

## **WARNING**

- Do not use the stabilizer jacks to support the recreational vehicle while under the vehicle or changing tires. The stabilizer jacks are designed as a stabilizing system only. Do not use the stabilizer jacks as a jack or in conjunction with a jack.
- Never raise the recreational vehicle by placing the jack under the axle, springs or any attachment parts.

**Failure to comply with these guidelines could result in damage to the vehicle and risk causing serious injury or death.**

### **When replacing tires:**

- Be sure to use only tires that are rated for recreation vehicle use. The use of passenger tires should be avoided. The load rating/range embossed on the sidewall of passenger tires must be de-rated accordingly; they do not have the same load capability as tires that are specifically identified for recreational vehicle use. Failure to use tires that are properly matched to your recreational vehicle could lead to premature tire wear or less than optimum trailer handling.
- Be sure to replace it with a tire of the same size and specifications (refer to the Federal Certification label.)

If you experience a flat tire on your recreational vehicle while driving, gradually decrease your speed and move the recreational vehicle to a safe place on the side of the road.

## SECTION 4: VEHICLE OPERATION

1. Keep the recreational vehicle attached to the tow vehicle. Block the tire on the opposite side of the recreational vehicle from the tire you are changing.
2. Loosen the wheel lug on the tire you are changing before jacking up the vehicle. DO NOT remove the lug nuts; only loosen them for ease of removal when the tire is off the ground.
3. Locate the mainframe rail of the trailer (it spans from front-to-back just inside the tires).
4. To raise the recreational vehicle, place the jack (hydraulic or screw) under the main frame rail. It must be just ahead of the front tire or just behind the rear tire.

### **Tire Replacement**

Any service or warranty coverage on tires is to be handled by the tire manufacturer or the store representing the brand installed on your recreation vehicle. They are not to be returned to your dealer or recreation vehicle manufacturer.

**If you have questions regarding your tires, contact the tire manufacturer.**

### **SPARE TIRE CARRIER (IF SO EQUIPPED)**

If your recreational vehicle is equipped with a spare tire, it will either be mounted under the unit (hoist) or on the rear bumper.

#### **Hoist Mount**

**⚠ WARNING**

DO NOT exceed the maximum load capacities of 100 lbs. for the hoist. DO NOT use air driven guns or impact wrenches to lift the spare tire to the travel position.

Depending on your model, the spare tire may have (side or bottom) brackets or it will be mounted against the underside of the recreation vehicle (flush mount) to give it stability in travel.



**Bracket Mount Travel Position**



**Hoist Mount Travel Position**

**NOTE:** If your spare tire is a flush mount application, it must make contact with the underside of the recreational vehicle to insure maximum road clearance and stability in travel. Raising and lowering the hoist

### **Raising and lowering the hoist**

The crank handle to raise and lower the tire will be located (fastened to the sidewall) in a basement compartment of the recreational vehicle. Insert the crank handle into the crank access port located either in the center of the rear bumper, or on the sidewall of the RV. Turn the crank handle to raise/lower the tire. Two “crisp breaks” must be heard and felt to insure the proper seating of the tire for travel.





**NOTE:** If the manual crank access port is located in a slideout, the slideout room must be in the travel position to allow the crank to reach the mechanism used to raise or lower the tire.

SPARE TIRE  
MANUAL CRANK

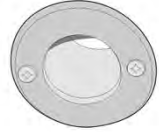

Crank Access Port

### Securing the spare tire

To secure the spare tire in the travel position, put the steel hoist lift support located on the end of the cable through the rim of the tire. The hoist lift support clips need to seat inside the center hole of the tire rim. The valve stem of the tire **MUST** be pointed up (toward the bottom of the RV).



### Bumper Mount:

The spare tire bracket can be released and extended down to access a storage compartment at the rear of the trailer without removing the tire.

#### To extend the tire down

1. Remove the cotter key from the pin holding the tire carrier in place.
2. Remove the pin and extend the carrier away from the trailer.



**Always return the tire carrier to the upright position and lock it in place while traveling.**

#### To remove the tire from the tire carrier

1. Remove the lug nuts holding the tire in place.
2. Remove the support bracket from the bottom lug.
3. Pull the tire from the tire carrier.

#### To install the tire on the tire carrier

1. Place the tire on the carrier with the top lug bolt inserted into one of the holes in the tire rim and the bottom lug bolt in the center of the rim.
2. Install the top lug nut.
3. Place the support bracket over the bottom lug bolt across the center of the rim (photo).
4. Install the bottom lug nut over the support bracket.
5. Tighten the lug nuts securely before returning to travel.



Bumper Mount

## **SECTION 4: VEHICLE OPERATION**

### **Vinyl Tire Cover (if so equipped)**

Your tires are manufactured with components that cause “bleeding” onto the tire cover. To prevent this, it is recommended to use a separator (garbage bag, paper, cloth, etc.) between the tire and the cover.

## **SETTING UP YOUR RECREATION VEHICLE**

- Position the RV as desired.
- Level the RV (side-to-side). Leveling your recreation vehicle is important as the water drainage systems are designed with proper slope and must be level for proper operation, and the appliances perform best when level.
- Block the wheels securely to prevent the RV from moving.

### **Travel Trailer Set Up**

1. Unhook the wire harness/connector plug, safety chains and breakaway switch lanyard.
2. Install the dolly wheel or platform.
3. Release the weight distributing bars (customer supplied).
4. Open the tongue jack coupler latch.
5. Turn the tongue jack crank to raise the coupler above the hitch ball.
6. Level the RV (front-to-back) with the tongue jack crank.
7. lower stabilizer jacks (If applicable).
8. Pull the tow vehicle away, as desired.

### **Fifth Wheel Set Up**

1. Drop the landing gear (important!) See the operator’s manual for proper operation.
2. Disconnect the wire harness/connector plug and breakaway switch lanyard.
3. Drop the truck tailgate (if applicable).
4. Gently put your truck into reverse (don’t give it any fuel/acceleration). This effectively moves the kingpin off the locking bar that will allow you to disengage it.
5. Step on brake and apply parking brake.
6. Disengage the locking bar and unhitch.
7. Drive away.
8. Adjust the fifth-wheel height for proper front to back leveling of the RV.

## **AWNINGS (IF SO EQUIPPED)**

### **WARNING**

Awnings must be closed (and locked if applicable) while the RV in transit.

### **CAUTION**

The effects of wind and rain on an awning are unpredictable and can cause severe damage to the awning and/or the recreation vehicle. **Retract the awning if:**

- If wind or extended periods of rain are expected
- If you leave the RV unattended for a length of time, to avoid unexpected climate conditions.

### **Awning Care**

Keep your awnings clean and in good condition to prevent costly repairs.

- Periodically check that the fasteners are tight. Tighten if necessary.
- Keep the awning fabric clean. For detailed cleaning information, refer to the manufacturer's owner information.

Your recreation vehicle may include one or more of the following options:

- Power window awning
- Slide out awnings
- Power awning over entrance door

Power switches to operate the awnings are typically found in the control panel above the entrance door.

### **Electric Patio Awning With Remote Control**



**NOTE:** The electric awning requires connection to a 120-volt power source. Make sure you have sufficient power available before operating your awning (refer to Electrical Systems, Calculating electrical load).

### **In Motion Detector (if so equipped)**

Some patio awnings are equipped with a motion detector. If the patio awning experiences extreme or excessive movement, it will automatically retract to the travel mode position.

For detailed safety and operating information, refer to the manufacturer's user guide.

## **SECTION 4: VEHICLE OPERATION**

**Notes:**

**ELECTRIC SLIDE ROOM(S) (IF SO EQUIPPED)**

The mechanical components of the slide out are gear driven. Electric powered slideout room systems have a manual override to allow you to extend or retract the slideout room(s) in case of a power loss.

**Make sure you have sufficient power available before operating your slideout system.**

**Level the RV prior to extending the slideout.**

Slideout switches are typically located inside the RV, either in the command center or on the wall.

**⚠ WARNING**

- Make sure the interior slideout room path and the slideout room itself is clear of people and objects before operating.
- Keep away from the slide rails and gear assembly when the room is in motion. They may pinch or catch on loose clothing causing personal injury.

**Failure to follow these instructions could result in serious injury or death.**

**⚠ CAUTION**

These guidelines should be followed when using your slideout room:

- Make sure the slideout is in the closed position prior to hooking the unit to the tow vehicle.
- The recreation vehicle **must be level** before operating the slideout room. Water leaks and other problems could result if the slideout is operated without leveling the RV.
- Do not place excessive weight** in the slideout room. It can cause the slideout room to malfunction and cause damage to the slideout.
- Do not over extend/retract the slide out room. Release the switch immediately once the room has been fully extended/retracted. Over extending/retracting the slide out room may result in damage to the stop rod and bracket.
- Additional support jacks are not needed under the slideout. Damage can occur to your slideout room from improper use of aftermarket support jacks.

**General Slideout Operation**

- The auxiliary battery (customer supplied) must be fully charged** and connected. **If possible, the RV should be hooked up to 120-volt AC power so the converter operates.**
- The RV must be level and the **stabilizer jacks in the extended position.**
- Slideout switches are typically located inside the RV, either in the command center or on the wall.
- To extend the slideout, locate the slideout control switch and press the OUT section of the switch; hold until the slideout room stops (travel time is approx. 25 seconds).
- To retract the slideout, press the in section of the slideout control switch and hold it until the slideout is fully retracted.

## SECTION 5: SLIDEOUT SYSTEMS

- Operating the switch after the room is fully extended or retracted may damage the switch and motor.

After the slideout is extended, visually inspect the slideout and the surrounding area to make sure the slideout has extended properly and has adequate clearance from any outside obstructions.

If the slideout is equipped with rubber seals, verify that the corners of the black rubber seal are set up correctly. The seal corners are cut at a 45° angle. The top of the outside seal must overlap the side of the seal to avoid the possibility of water penetration. On the inside seal, the side seal should overlap the top.



**Slideout Overlap-  
Outside**

**NOTE:** For long-term storage it is recommend the room be closed (retracted).

### General Slideout Troubleshooting Checklist

**NOTE:** For additional troubleshooting information, refer to the specific slideout system detail.

#### **If the slideout does not move when the slideout switch is depressed, follow these steps:**

- Check the auxiliary battery (customer supplied) for a full charge and good wire connections.
- Check the 12-volt fuse or circuit breaker.
- Check for loose connections at the slideout motor.

#### **If the slideout still will not operate, follow these steps:**

- If the slideout is extended, refer to the section on operating the specific slideout system installed on your RV.
- If the slideout is retracted, leave it in that position.

#### **If the slideout extends crooked or only one side moves:**

- Follow steps on overriding the specific slideout system installed on your RV.
- You may need to push the side that is not sliding to get it to retract all the way.

Contact your dealer or customer service for repair assistance.

### **Slideout Systems**

Your RV may be equipped with one or more of the following slideout systems.

#### **Flush Floor Slideout**

For optimum performance, the slideout system requires full battery current and voltage. Although the system is almost maintenance free, actuate the room once or twice a month to keep the seals and internal moving parts lubricated.

**NOTE:** For long-term storage it is recommend the room be closed (retracted).

### Trouble shooting the flush floor slideout

Refer to the general troubleshooting check list before proceeding.

### Electric Operation

**NOTE:** Install transit bars (if so equipped) on the slideout room during storage and transportation.

### Extending/retracting the room

1. Level the unit.
2. Main Power switch at stepwell (locations may vary) must be ON.
3. Verify the battery is fully charged and hooked up to the electrical system.
4. Remove the transit bars (if so equipped) if extending the slideout, and install them if retracting the room for travel.
5. Press and hold the IN/OUT switch in the OUT position until the room is fully extended and stops moving. Hold the switch in the IN position to retract the room.
6. Release the switch, which will lock the room into position. If the slideout switch is held after the room is fully extended or retracted, the control will sense that the room has stopped and will shut the motor off after a few seconds.



### Manual Operation for the flush floor slideout

Locate the crank extension under the inside of the frame (**Fig. 1 and 2**). Attach a standard fifth wheel landing gear crank handle, a 3/4" socket and ratchet, or drill and nut driver.

Rotate the extension clockwise to retract the slideout and counterclockwise to extend it.

**DO NOT** attempt to disengage the motor as the actuator is "manual ready".

## CAUTION

- Always disconnect battery from system prior to manually operating system. Failure to disconnect battery can cause electricity to back feed through the motor and cause serious damage to the system as well as void the warranty
- Use **EXTREME CAUTION when extending/retracting the room using the manual override feature.** The gears can be stripped out if the room is manually retracted/extended to its fullest extent and the operator continues to rotate manual override. Damage can also occur to the slide components, slide room structure or trim components. Damages due to misuse of the manual override feature will void any and all claims to the Limited Warranty.

## SECTION 5: SLIDEOUT SYSTEMS

### MANUAL OPERATION THROUGH FRAME



**Fig. 1- Crank Handle**



**Fig. 2-Through Frame Crank Extension w/Pin**

### MANUAL OPERATION IN FRAME



**Fig. 3-Hex Head Crank Extension**



**Fig. 4-Ratchet**

### Schwintek In-Wall Slideout System

The in-wall slideout system requires no maintenance or adjustments. This system has two vertical columns with a drive motor located at the top of each column. The right and left motors are synchronized by a circuit board. Schwintek slideouts are typically used on both towables and motorhomes.



**NOTE:** Do not operate the switch after the room is fully extended or retracted as damage can occur to the motor and/or switch.

To operate the slideout using a wireless remote (if so equipped):

- Press the on/off button to power on the remote.
- Press the corresponding button of the slideout you want to operate.
- Press and hold the (extend/retract) arrow button to move the room in or out.
- Press the on/off button once more to power off the remote.

**ALWAYS** allow the controller to stop both motors before releasing the switch button.

**DO NOT** try to time the end of the stroke by releasing the button early.

### Maintenance

## **⚠ WARNING**

Do not work on your system unless the 12-volt DC (auxiliary battery) and 120-volt AC electrical systems (shore line power cord) have been disconnected.



This slideout system requires very little maintenance. It contains a pre-lubed bearing that is lubricated when the room is moved in and out. Do not spray oil or grease on the rails while the room is extended.

### **Trouble shooting the in-wall slideout system**

**Checking Fuses:** The in-wall slide requires a minimum 30-amp fuse. Check the load center for blown fuses and replace any if necessary. If the fuse blows immediately upon replacement, there is a problem with the wiring to the in-wall slide control box. A qualified service person should be called to check and repair.

**Obstructions:** Check both inside and outside for possible obstructions. Also check for smaller objects that may be wedged under the floor or in the sides of the unit. Remove any obstructions before proceeding.

**Error Codes:** Refer to the error codes section for codes and instructions on how to locate the in-wall slide controller.

**Low Voltage:** The in-wall slide controller can operate with as little as 8 volts; however, with lower voltages the amperage requirement is greater. Check the voltage at the controller and if it is lower than 11 volts, it is recommended that the battery be placed on a charger until it is fully charged. It may be possible to “jump” the RV battery temporarily to extend or retract the room. Consult Customer Service before attempting to “jump” the auxiliary battery.

**Only 1 Side Moving:** The slide room has a separate motor to operate each side of the room. If only 1 side is moving, with another person’s assistance, press the switch to extend or retract the room while pushing the non-moving side in the appropriate direction. On larger rooms it may be necessary to have 2 or more people pushing the room.

**Non-moving side moved manually:** Try to push the non-moving side in and out. If a motor shaft has broken it will be possible to move that side of the room several inches by hand. Larger rooms may require several people to push.

**Debris in the rack:** Check all 4 gear racks on the side of the room for debris.

**Status LEDs lights:** Locate the slide controller for the slideout in question. Check the status LED lights while pressing the slideout direction switch (in both the extend and retract mode).

### **Manual override for the in-wall slideout**

The slideout system comes with an “electronic” manual override. In event the slide out does not extend or retract follow these steps to override the system which should allow the slideout to be retracted.



**NOTE:** Fuses for the slideouts can be found in the load center and may be designated as auxiliary or slideout motor.

1. Locate the slideout system controllers. There should be one for each slideout on the recreation vehicle. They are typically located on the forward wall or ceiling of a basement compartment. In some models they may be behind a cargo lined panel.
2. The malfunctioning controller should have a flashing red LED indicating a halt signal fault (will flash 8 or 9 times).
3. Press the “mode button” six times quickly, then press a seventh time and hold for approximately 5 seconds.

## SECTION 5: SLIDEOUT SYSTEMS

- The red and green LED's will flash indicating you are in override mode. Release the mode button.
- Using either a wall or command center panel switch, press and hold the switch toward the word IN or RETRACT until the unit comes in completely. This will allow you to get the recreation vehicle to a service center to have the slideout malfunction diagnosed.

### CAUTION

Call your dealer or Customer Service if:

- During the override procedure the motors are not synchronized. Visually watch the room, and if one side is moving significantly slower than the other (or not at all).
- If the system stalls out before reaching end of stroke OR if the room does not close and seal tightly.

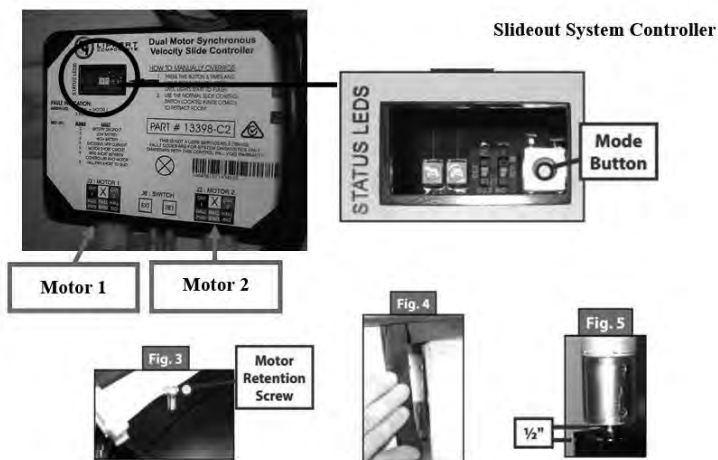

### Manually pushing in the slideout

- Locate the slideout system controller.
- Unplug motor 1 and motor 2 connectors at the bottom of the slideout controller. This releases the motor brakes for each motor.
- The slideout room can now be manually pushed in. Larger rooms may require several people to push or pull them.
- Keep both sides of the slideout relatively even while pushing/pulling.
- When the room is completely in, *plug both motor connectors back into the control module. This will apply the motor brakes for road travel.*

### Disengage motors, manually retract the room and travel lock

- Locate and remove the motor retention screw, which can be found near the top of each vertical column (**Fig. 3**).
- Bend back the wipe seal and visually locate the motor (**Fig. 4**).
- Pull the motor up until it disengages (about 1/2 inch).
- Repeat this process for both sides of the slide room.
- Physically push/ pull the room back into the opening; keep both sides relatively even.

6. The room must be travel locked to keep the room in place for road travel.

### **WARNING**

**DO NOT MOVE THE RV UNLESS THE MOTORS ARE PLUGGED IN TO THE CONTROLLER AND THERE IS BATTERY POWER TO THE RV. THIS SETS THE BRAKES ON THE SLIDEOUTS TO PREVENT THEM FROM MOVING DURING TRANSIT.**

#### **Error Codes**

When an error code occurs during operation, the board LEDs lights will indicate where the problem is. For motor specific faults the green LED will blink (1) time for motor #1 and (2) times for motor #2. The red LED will blink 2 to 9 times depending on the error code. Error codes are as follows:

- 2 times **Battery capacity is low** enough to drop below 6 volts while running.
- 3 times **Battery (low) voltage** is below 8 volts at the start of a cycle.
- 4 times **Battery (high) voltage** is greater than 18 volts.
- 5 times **Excessive motor current** (high amperage) also indicated by (1) side of the slide continually stalling.
- 6 times **Motor short circuit:** motor or wiring to motor has shorted out.
- 8 times **Hall signal not present:** encoder not providing a signal; usually a wiring problem.
- 9 times **Hall power short to ground:** power to encoder has been shorted to ground; usually a wiring problem.

The board will need to be reset after an error code. Energizing the extend / retract switch will reset the board; energizing it a second time will return it to normal operation.

Refer to the Schwintek Slide Room Operation Guide for additional troubleshooting information, or contact Lippert at (866) 524-7821 or at [www.lci1.com](http://www.lci1.com).

#### **Norco Slideout System**

The Norco slideout system is a cable driven slide out used typically on towable products.

- The cables guide the room in or out, while the Accu-Slide mechanism evenly powers the corners keeping the room square.
- Motors and cables are behind the interior fascia board around the slideout opening.
- Cables may stretch over time. Average stretch will be approximately 1/8" but it will not affect the function and does not require adjustment.
- Slideout runs off the DC power in the RV.
- Rubber wipes prevent debris from entering the unit and actuation guides the bulb seals to close tightly.
- Self-locking motor freezes the room in any position of travel.
- Slideout is supported by rollers or wear bars not the cables. Cables are used to keep the slideout balanced on the rollers.

**If the room will not activate**, generally there is no 12V power to the drive motor. The motor is equipped with a hex drive override shaft.

This drive can be activated using an electric drill and the flexible shaft provided with each unit (or use a ratchet to actuate the motor) to pull the room in or out. **If the motor is functioning, check the room for obstructions.**

## SECTION 5: SLIDEOUT SYSTEMS

### Norco Slideout Manual Operation

1. Locate the included flexible shaft in your owner's packet.
2. Attach flexible shaft to the 1/4" hex fitting on the end of the motor.
3. Attach 1/4" socket & ratchet, or drill to the other end, and turn in the proper direction to move the room.
4. If the cables tighten, and the motor is difficult to turn, **REVERSE THE DIRECTION. OVER-TORQUEING CAN HAPPEN, RESULTING IN SEVERE DAMAGE.**



### Power Gear Slideout System

**Manual Override** - The slideout system is equipped with a manual override that allows you to extend or retract the room in the event of a loss of power.

## **⚠ CAUTION**

- Always disconnect battery from system prior to manually operating system. Failure to disconnect battery can cause electricity to back feed through the motor and cause serious damage to the system as well as void the warranty
- Use **EXTREME CAUTION** when extending/retracting the room using the manual override feature. The gears can be stripped out if the room is manually retracted/extended to its fullest extent and the operator continues to rotate manual override. Damage can also occur to the slide components, slide room structure or trim components. Damages due to misuse of the manual override feature will void any and all claims to the Limited Warranty.

**If the room does not move when the switch is pressed, check the following:**

- Make sure the slideout system is turned on.
- Battery is fully charged and connected.
- Transit bars have been removed (if so equipped).

**⚠ WARNING**

When the motor brake is disengaged the slideout room **WILL NOT** lock into place and will not be sealed. When the room has been manually retracted, be sure to install transit bars (if so equipped) and return the motor brake lever to its normal engaged position in order to seal and lock the room into position.

**If the room still does not move when the switch is pressed, follow the steps below to manually override the slideout room.**

1. Turn the Main Power OFF. The override will not work if it has power going to it. **Do not work on the system unless the battery is disconnected.**
2. Locate the slideout controller. There are two versions of the controller.
3. **Version 1**, unplug the 6 pin wiring harness from the controller.
4. **Version 2**, remove one of the motor leads, either the motor I or motor II lead from the controller.
5. Locate the slideout motor (Fig. 1) mounted to one of the slideout rails. Some models may require removal of the underbelly or cover to access the motor. In a bedroom slideout, it may be located under the bed.
6. Rotate the brake lever, on the backside of the motor, counter-clockwise (looking from the rear of the motor) about 1/8 of a turn to the released position (Fig. 2). This will release the brake that holds the room in place.
7. Locate the manual override for the slideout system (Fig. 1).

**Fig. 1 - Motor & manual override general location**

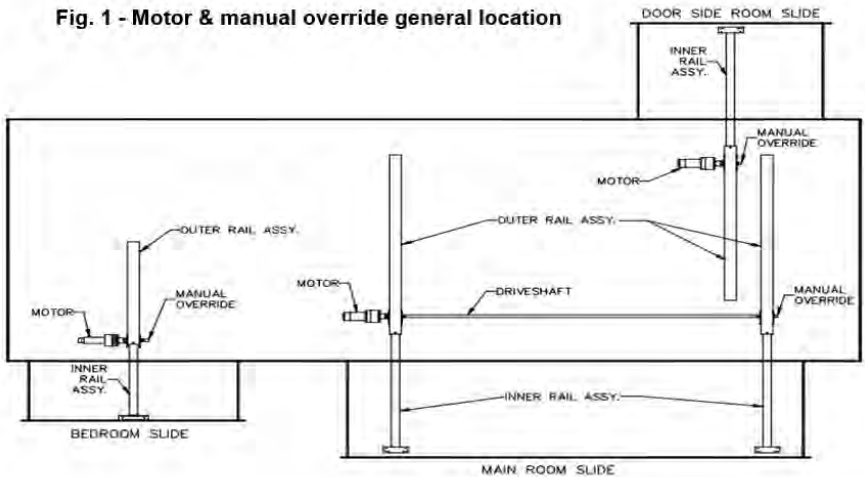

8. The room is now free to move. Using either a 5/8" or 3/4" wrench or socket, crank the room either in or out completely. If the slideout system is supplied with a gearbox override (optional), use the crank handle to move the room.
9. When the rooms is fully in or out have one person apply pressure to the wrench/ratchet and return the brake lever to its engaged position. This ensures the room is locked into a sealed position.

## SECTION 5: SLIDEOUT SYSTEMS

- Install the transit bars (if so equipped) to the slideout room and take the unit to an authorized dealer for service.



Refer to the Power Gear® Electric Slideout Operation Manual for detailed operation, safety and troubleshooting information.

### Power Gear Slim Rack Slideout System

The Power Gear® Slim Rack slideout is typically used for slideouts 144" long and longer.



- It is operated by a 12VDC electric motor.
- The system is equipped with a manual override allowing the room to be extended / retracted in the event of a power loss.
- The system has a controller (Fig 1) with programmable stops that stop the motor when the room is fully extended or retracted.
- The controller has the ability to detect faults for easier troubleshooting.
- A wall mounted touchpad allows room movement and provides end user feedback.

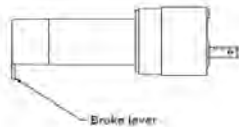

Fig. 2 - Motor brake lever

### Operating the Slideout

The slideout will not function until the stops are properly set or faults are cleared.

A solid "ON" GREEN LED indicates room movement.

The RED LED indicates a fault or a problem with the system. (Refer to the *Fault Diagnostics / Troubleshooting*).

**Prior to moving the slideout room set the parking brake.**

To ensure ample voltage is being supplied to the slideout system motor, power should be supplied from one of the following sources:

- Attach the RV to shore power. Have the motorhome engine running.
- Turn on the generator.

### Extending/retracting the room:

- Engine or generator must be running, or plugged into shore power.
- Transmission must be in park or neutral (if applicable).
- Set the parking brake and level the unit.
- Remove transit bars (if so equipped) if extending the room; install if retracting.
- Turn ON the on/off switch or key.
- Press and hold the OUT button (Fig 4). To retract, press and hold the IN button. There will be a slight delay before the room begins moving.
- The GREEN LED should be solid ON when room is in motion.



Fig.1 Slideout Controller



Touchpad



Figure 2 Set Stops/Clear Fault Button



Figure 3 Room Slideout Motor Buttons



Figure 4 Touchpad

8. Release the OUT button when the room is fully extended or the IN button when fully retracted, and stops moving.
9. Turn **OFF** the on/off switch or key.

**Fault Diagnostics / Troubleshooting:** The control has the ability to detect and display several faults. When a fault is detected, room movement stops and two different LEDs will flash in a pattern.

The RED FAULT CODE LED (Fig 4) will flash a number of times corresponding to a specific fault code (refer to the Fault Code Chart).

The GREEN ROOM MOVEMENT LED (Fig 4) will flash GREEN a number of times corresponding to which motor has the associated fault.

Example: (4) RED flashes and (2) GREEN flashes indicate a motor fault on motor 2.

**MAJOR and MINOR faults;** faults must be cleared for the room to operate normally.

- **MINOR** faults can be cleared by pushing and releasing the **IN** or **OUT** buttons on the wall touchpad (Fig 4).
- **MAJOR** faults must be cleared by pushing and releasing the **SET STOPS/CLEAR FAULTS** button located on the back of the wall touchpad (Fig 2).

**NOTE:** For MAJOR faults, the control must be overridden by following the EMERGENCY RETRACT MODE in the OVERRIDE MODES section.

Fault Code	Fault Type	Fault Codes		
		Description	Possible Cause	Possible Solution
1	Major	Stops not programmed	-Stops have not been set -Stops were cleared -Stops were improperly set	Steps need to be programmed by an authorized service facility.
2	Minor	System Fault	-Obstruction present -Excessive system drag	Run room in opposite direction. If it continues to move in the opposite direction, remove obstruction, excessive weight in room or repair of damaged component. If room stops moving in opposite direction, observe fault code and refer to this chart
4	Major	Excessive Battery Voltage	-Bad or loose connection -Defective harness -Open or shorted motor	-Check all connections at control box and motor -Check the harness for broken wires. -Put 12.0 VDC direct to the motor. If it does not run replace the motor.

## SECTION 5: SLIDEOUT SYSTEMS

6	Minor		Supply voltage to control box is 17.0 V DC or greater	Check 2-pin power connector at control box. If the voltage is 17.0 VDC or higher, contact O.E.M for power and ground supplies
Park brake LED flashing			-Parking brake not set (if applicable) -Ground signal lost at park brake control	-Set parking brake (if applicable) -Check for continuity to ground on wire plugged into park brake connector at control box
Low voltage LED flashing			Incoming voltage to control box is below 12.0 VDC	Check 2-pin power connector at control box. If voltage is below 12.0 VDC contact O.E.M for power and ground supplies.

### Preventative Maintenance

The Power Gear® slideout system requires very little maintenance. Read and follow these procedures:

- When the room is extended, visually inspect the slide rail assemblies. Check for excess buildup of dirt or foreign material; remove any debris that may be present.
- If the system squeaks or makes any noises, blow out any debris from the gear rack arms and apply a dry lubricant to prevent and/or stop squeaking.

Refer to the Power Gear® website [www.powergearus.com](http://www.powergearus.com) for additional information.

### Override Modes:

In the event of component failure or loss of system power, your slideout can be manually overridden and retracted for travel.



**NOTE:** During the override procedure, the unit will exit this mode if the room has not been moved for two (2) minutes or if a fault is detected during room movement. The Fault Code (RED) and Room or Lock Movement (GREEN) LEDs will flash rapidly for 10 seconds to indicate the override procedure failed. After 10 seconds of flashing, the control will automatically default to FAULT CODE 1. Programming must be restarted.



**NOTE:** After overriding the system, the room control will need to be re-programmed by an OEM authorized dealer.



### Emergency Retract Mode

Use this procedure when there is **NO** loss of power or electrical problem with the system.

1. Remove the touchpad (Fig 4) from the wall.
2. Prior to clearing the MAJOR fault, record the number of RED & GREEN flashes observed on the touchpad (Fig 6). This information will help your dealer/service center in troubleshooting the slideout system.
3. Press and hold the SET STOPS/CLEAR FAULTS button on the back of the touchpad for five (5) seconds (Fig 2). Both RED & GREEN LEDs will be on solid while pressing this button. After 5 seconds, the GREEN LED will begin flashing and the RED LED will remain solid on.
4. The unit is now ready to retract the room. Press and hold the ROOM SLIDEOUT MOTOR buttons 1 and 2 on the back of the touchpad (Fig 3).

# of RED flashes	# of GREEN flashes

Figure 6

### CAUTION

It is very important to note that during this procedure, the slideout control has NO stop locations. Use a second person to assist in determining when the room is retracted. Damage to the room can occur if the room is retracted too far.

Press the IN button on the front of the wall touchpad until the room is fully retracted. If one side of the room needs to retract further in order to get a good seal, press and hold the motor button (Fig 3) corresponding to ONLY the motor you want to move. Press the IN button on the front of the touchpad to retract the room the remainder of the way.

5. Re-install the wall touchpad.
6. Take the unit to an OEM certified dealer for repairs.

### Manually Retract Room with Ratchet and Socket

If the power is lost to the slideout motor(s) or the override mode above will not work, the room may be manually retracted using a ratchet and socket attached to the end of the coupler (Fig 11).

1. Gain access to the VERTICAL CHANNEL assembly from inside or outside of the coach (whichever is more convenient). Remove the trim and flange pieces on the slideout room box.
2. If applicable, remove the top screw from the bulb seal at the top of the VERTICAL CHANNEL (Fig 8).
3. Pull down the bulb seal and remove the motor cover (Fig 9). The motor seal may stick to the bulb seal.
4. Using a pick tool, remove the end of the retaining spring from the motor spring clip (Fig 10A). If not equipped with a retaining spring, loosen the motor retaining screw (Fig 10B).
5. Unplug the motor from the harness and remove the motor by lifting it up and out.
6. Repeat steps 1-4 for the other side.
7. Place a socket wrench with a 3-inch extension and a 5/8" deep well socket (Fig 12) through the motor access opening and seat the socket onto the coupler (Fig 13). One person alternating from side to side of the room can retract a 1500 lb. room with or without a ramp.

## SECTION 5: SLIDEOUT SYSTEMS



**NOTE:** One person on each side of the room with a ratchet and socket will expedite the process. Room moves ¼ inch for every 30 to 40 degree turn of the wrench.

8. Secure the room in place by either:
  - Re-installing the motors (making sure the end of the retaining screw is re-hooked to the motor spring clip (Fig 10A).
  - Torque the motor retaining screw to 40 inch/lbs. (Fig 10B) and the motor retainer is fully engaged.
  - Use a travel lock, (a 2x4 cut to size), etc.
  - **Refer to Fig 10A and 10B for proper seating of the motor.**
9. Have the slideout room serviced by an OEM authorized dealer as soon as possible. Do not operate the room until service is complete as damage to the room may result.



Figure 8 Removing the bulb seal screw



Figure 9



Figure 10A



Figure 10B

**NOTE: Motor shown properly seated. No gap between mounting bracket and block.**

**Motor Retaining Screw**



Figure 11 Coupler



Figure 12 Ratchet with 3/8" extension and 5/8" deep well socket



Figure 13 Ratchet inside motor access with socket on coupler

### **Power Gear Ram Slideout System**

Typically used for Class C motorhomes.

#### **Manual Override Procedure**

The system has been equipped with 3/4" hex override couplers located on the drive component of the system. Due to the size and weight of some rooms, assistance may be needed to push the room in.

Use the following steps to mechanically operate the room:

1. Locate the ABS motor access cover for the slideout. This cover will be located inside one of the storage compartments under the slide room up at the top of the compartment.
2. Remove 4 screws holding the panel to the top of the compartment. Remove the cover.
3. Unplug the motor leads at the connector. Gray connector with red and black wires.
4. To release the motor brake you must depress the spring lock lever, which then allows you to pivot the brake lever, which in turn releases the brake. These parts are located inside the rubber boot wire tied over the motor. You must manipulate these parts **without** removing the rubber boot. **As noted on the side-by-side photo, removing this boot will void your motor warranty.** These photos will help you figure out how this works. The side-by-side photo (below) shows the spring lock lever and the brake lever.
5. The spring lock lever is a thin metal arm with a slight bend at the end, which will hold the brake lever in the released position.
6. The brake lever is the heavier thicker metal arm with the hole in the end.
7. The normal position for these two levers is to be parallel to each other as shown in the first side-by-side photo. The motor brake is engaged with levers side by side.
8. The brake lever is moveable; the spring lock lever is not moveable. To release the brake lever, you must push the bent end of the spring lock lever away from the brake lever; this will allow you to pivot the brake lever so it moves over on top of the spring lock lever. The bent end will hold the brake lever in the released position. (photo shows this "bend").
9. Once the brake motor is released, you will need to remove the skirting on the side of the slideout floor where the hex override is located.
10. Use a ratchet with a 3/4" socket (or wrench) to turn the hex override and manually move the slideout.
11. When the slideout is retracted, check to make sure you have a good seal, and replace the skirting on the slideout.

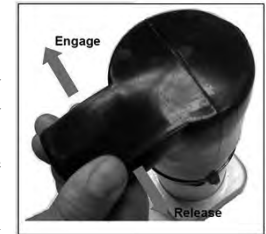
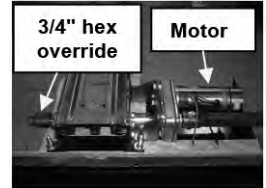
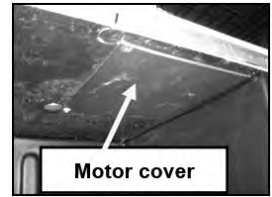

## SECTION 5: SLIDEOUT SYSTEMS

12. Return the brake release lever back to the “engaged” position (parallel to the spring lock lever). Pressing the bent end of the spring lock lever will allow the brake lever to be moved.
13. Plug the motor connector back in again.
14. Replace the plastic motor cover with the 4 screws removed previously.
15. Take the unit to an authorized dealer for service.

For further information, refer to the manufacturer’s **owner’s manual**.

**DO NOT** remove boot. Removal of rubber boot will void manufacturer’s warranty. Rubber boot removed from end of motor only to show brake lever and spring lock.

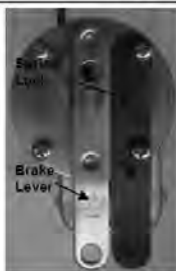

Brake lever engaged

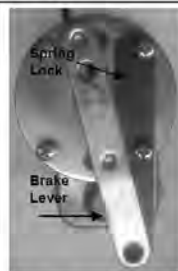

Brake lever released

***THE ELECTRICAL SYSTEM***

The RV electrical system is comprised of two independent electrical systems. One operates off of 12-volt DC power and the other off of 120-volt 60hz AC power. All installations have been made in compliance with industry standards applicable on the date of manufacture. Because the electrical equipment and associated circuitry are engineered into a dedicated system specific to your RV, do not make unauthorized changes or add fixed appliances to it. **Changes or additions made after delivery may result in a hazardous condition.**

Service and/or modification of the electrical system should only be performed by qualified electrical technicians using approved materials, components, and methods meeting current safety and code requirements. Consult your dealer’s service department for assistance.

To read more about the various components incorporated into the RV electrical system, please refer to the information contained in your Warranty Packet.

For motorized vehicles, consult the Chassis Guide for information pertaining to the chassis drivetrain electrical system.

**Electrical System Maintenance**

Before working on the electrical system:

- Make sure the inverter/charger (if so equipped) is turned “off” before disconnecting batteries. Disconnect the shore power cord.
- If equipped with a generator, turn off the generator and disable the automatic generator start functionality (if so equipped).
- Turn off the battery disconnect switch (if so equipped)
- Turn off the 120V main circuit breaker.
- Disconnect the negative 12VDC battery terminal from the battery.

** WARNING**

Use caution when using metal tools. If a tool contacts a battery terminal or metal connected to it, a short circuit could occur which could cause personal injury, explosion or fire.

***IN CASE OF AN ELECTRICAL FIRE***

** WARNING**

Do not attempt to use water to put out an electrical fire. Water can spread some types of fire, and electrocution is possible with an electrical fire.

**EVERYONE SHOULD EVACUATE THE RV IMMEDIATELY:**

- Switch the 120-volt main circuit breaker to the “off” position. It is important that everyone knows where to find the main circuit breaker and how it operates.
- Disconnect the negative battery cable(s) at the battery.
- Disconnect the power cord from the shore power receptacle.
- Turn “off” the generator (if so equipped).

Always have faulty or damaged wiring and electrical components repaired immediately.

## SECTION 6: ELECTRICAL SYSTEM

### **COMMAND CENTER**

The command center is typically located inside the entrance door or in the living area of the RV, and contains switches and controls for various electrical functions. Command center applications, configurations and components will vary by model.

#### **Command Center Panel or Command Center Panel with Switch Modules**

Items found on these panels may include:

- Fuel gauge and hour meter with switches for fuel pump and fuel levels; fuel station (if so equipped) on/off switch
- Lighted red pump and water heater switches (electric & LP gas)
- Generator start / stop switch; may include hour meter
- Tank heater switches
- Light switches for porch lights, exterior security lights, interior lights, awning LED lights, front cap LED accent lights, power entry step
- Cargo bed red lighted control switch
- Slideout control switches (press and hold to extend / retract)
- Awning control switches (press and hold to extend / retract)
- Systems monitor with LED indicators for tank levels and battery charge status
- Auto leveling control panel (for leveling the RV)
- Inverter panel (power switch with display)
- Power bunk bed lift control switch
- Speaker selector switch

#### **Command Center Modules Mounted To the Wall**

Some models may have the modules mounted directly to the interior wall of the vehicle. They are typically located near the entrance door.

#### **Touch Dimmer Switch:**

Certain models may include a touch dimmer switch next to the Command Center panel. (There are no interior light switches on the Command Center panel).

- Turn ON ceiling lights: Tap the LED light on the dimmer
- Turn OFF ceiling lights: Tap the LED light on the dimmer
- Dimmer: If lights are off, hold finger on the LED light and lights will begin turning on gradually until fully lit. If lights are on, hold finger on the LED light and lights begin to gradually turn off.

The dimmer has a memory so it remembers what the light setting was when the lights were turned OFF. When turned ON again, the lights return to that same setting.



**Command Center Panel**



**Command Center Panel w/Switch Modules**



**NOTE:** If your RV model includes the 5 way/8 way remote control: the LIGHT button on the remote only controls the awning LED lights.

***GFCI RECEPTACLE***

There is a ground fault current interrupter (GFCI) engineered into the electrical system. It is designed to reduce the possible injury caused by electric shock. The GFCI will not protect against short circuits or circuit overloads.

**Test all GFCI receptacles monthly:**

- Push in the GFCI “TEST” button. The GFCI “RESET” button should pop out indicating the GFCI receptacle has been “tripped” and interrupted 120-volt power.
- Push in the GFCI “RESET” button to restore 120-volt power.

Contact your independent dealer for assistance if the GFCI “RESET” button does not restore 120-volt power and pops back out.

A “tripped” GFCI breaker indicates that abnormally high 120-volt current flow (a ground fault) was detected. All ground faults must be repaired before use of the recreation vehicle. If the GFCI “RESET” button does not restore 120-volt power and pops back out. Contact your dealer for assistance.

***LCI ONE CONTROL® SYSTEM***

The system gives you control over many functions in your recreational vehicle from a touch screen control panel located inside the entrance door of the RV. The touch screen control panel can operate awnings, the leveling system, lighting, slide-outs etc.

The One Control System will **NOT** operate the hall light, lights located inside each slide-out, exterior amber/red marker lights, or the LED strip lights located on the front or rear caps.

The above mentioned devices can also be controlled with the following:

- Downloadable Wi-Fi phone app, The LCI One Control App can be downloaded to Android and Apple devices from GooglePlay or the Apple Store. Once the app is installed on your phone or tablet, you will be able to control these components through your device.
- Command Center switch panel.
- A pump switch at the outside utility center panel.

**Wi-Fi Operation of the One Control® System**

A wireless router is typically installed in a cabinet near the touchscreen control panel. This router works in conjunction with the One Control System. The label at the router location (**Fig 2**) has the password for the wireless router (8 alpha characters and case dependent). This password is necessary when connecting the One Control® System to an Android or Apple smartphone or tablet.

To use the system, select **My RV Control Panel (Fig 3)** from the menu. This opens the screen showing all the items that can be operated from the touchscreen, or the app.

The device selection screen (**Fig 4**) has icons depicting the different systems in your RV that can be controlled from the touchscreen, the app or the main switch control panel. To return to the previous menu, the BACK icon or the HOME icon in the bottom bar on the screen will return you to the previous screen.



## SECTION 6: ELECTRICAL SYSTEM

**NOTE:** If a device does not appear on your touchscreen then that particular system is not installed on your RV.

**Awning Operation:** Select the AWNING icon; the screen opens showing the awnings (Fig 5). If there are multiple awnings, there will be a selection for each awning at the left of the screen. Select the awning you want to control, then press and hold the EXTEND (B) or RETRACT (C) buttons. Select the back arrow (A) to return to the previous screen.



**Leveler Operation:** Select the LEVELER icon, the screen opens showing the leveler control panel (Fig 6). This screen will allow you to extend and retract the jacks and to auto level the RV. Press the AUTO LEVEL button (A) to begin leveling the RV.



Refer to the Lippert User Guide for the One Control system for more detailed information. Select the HOME icon to return to the previous screen.

**Slide-out Operation:** Select the SLIDES icon which will open the slideout screen (Fig 7). Slideouts will be numbered 1-4 on the touchscreen. The screen can display up to 4 slideouts. Press Slide 01, and then press (and hold) the OUT (A) button to extend the slide, or the IN (B) button to retract it. Repeat this action on the remaining slideouts. Select the back arrow to return to the device selection screen.



### IMPORTANT SAFETY FEATURE

**IF SLIDE 01 IS MISSING FROM THE LIST:** This indicates there is a problem with the bedroom slide-out. In order for the slideout to function properly, the bedroom door **MUST BE OPEN**. An electronic door catch has been installed to the wall in the bedroom behind the door (Fig 8). A second piece is mounted to the door (Fig 9). If the door is closed, the Slide 01 notification on the touchscreen display will disappear and the slide-out will NOT operate. When the bedroom door is opened and the catch pieces connect, the Slide 01 notification appears on the touchscreen display and the slide-out can then be operated normally.



**NOTE:** This same safety feature applies to the slide-out switch on the wall or on the Command Center switch panel. The bedroom door must be open and the catch pieces connected for the bedroom slide to work.



**DSI FLT - Direct Spark Ignition Fault (if so equipped):** This light above the GAS water heater switch on the Command Center panel indicates a problem with the LP portion of the water heater. When the GAS switch is turned on, the light will blink quickly 3 times and the water heater will ignite. The light will then remain off. If the light comes on and stays on, it indicates the gas side of the water heater has not fired and there is a problem with the igniter.

**This light does NOT appear on the touchscreens, remote or Wi-Fi app.**

**Operating the Lights:** Select the LIGHTING icon and the lighting control screen opens (**Fig 10**) allowing you to control lighting in your RV.

To operate, scroll through the list and find the light you want to control. Individual lighting controls will appear on this screen. If the switch is ON, the light bulb for each item will illuminate.

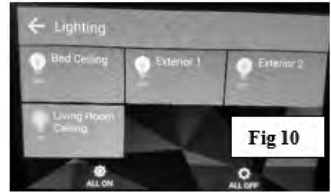

If the ALL ON switch is selected, all the lights shown on the screen will turn ON. Likewise selecting ALL OFF turns all the lights OFF.

All of the lights will light in steps to prevent a power surge.

**Light switches may have to be toggled twice for them to operate as this system is multiplexed with the command center panel and other wireless controllers in the RV.**

**Fuse Location:** There are two fuses controlling the Wi-Fi system and the multiplex network. They are the (2) red 10 amp fuses located in the load center (**Fig. 11**).

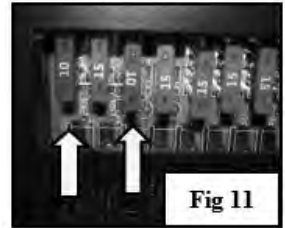

### **5-WAY AND 8-WAY POWER REMOTE (IF SO EQUIPPED)**

The remote is an optional item that may or may not be available for your RV.

This system gives you remote control over several functions in your RV. The 5-way remote will operate (4) systems (with motors) and (1) light circuit. The 8-way remote will operate (7) systems (with motors) and (1) light circuit. Examples of systems with motors include stabilizers, slideouts, and awnings. Both remotes operate in a similar fashion; the 8-way will have more "pages" on the display since it will operate more devices. The handheld remote is located in a holder inside the entrance door.



#### **Remote Operation**

To power on the remote, press the silver (HOME) button. The display will prompt you for a pin and show numbers on the screen. The default pin is 0,0,0,0. You should create a personal pin number. After you enter your pin number, the remote will display a menu of devices that can be controlled. To power off the remote, press and hold the "HOME" button for 5 seconds until the display goes dark.

#### **Programming a Pin**

The PIN code for the handheld remote provides personalized security, as well as a safety feature to prevent inadvertent activation of functions. These instructions apply only to the LCI wireless remote.

## SECTION 6: ELECTRICAL SYSTEM

### **Reset the handheld remote PIN code**

1. Press the silver “HOME” button to turn the remote ON.
2. Press and release the “HOME” button five times. The button with a picture of a key changes to the word “CONFIG”.
3. Press the “CONFIG” button. (Fig 1-A).
4. The remote will ask to reset the screen lock PIN code (Fig 2).
5. Press “Yes” (Fig 2-A)
6. The remote will display a message that the PIN has been reset (Fig 3).
7. Press “HOME” button and press “Set PIN” (Fig 4-A).
8. Enter a 4-digit PIN code (Fig 5).
9. Press “SAVE” (Fig 6-A).
10. Press “HOME” button.



When the keypad appears on the screen, enter the new 4-digit PIN (Fig 7).



### **Operating the handheld remote**

1. The menu screen will show sets of (4) functions (Fig 8). Select a function or press “NEXT” for more options (Fig 8-A).
2. To return to the previous menu screen press “PREV” (Fig 9-A).
3. The awning light can be turned ON and OFF by pressing “LIGHT” in the menu (Fig 10-A).
4. Press a component button in the menu (Fig 10) to enter the function operation screen (Fig 11). To return to the previous screen press the “HOME” button.



### Important remote control operating information

- **Never** attempt to operate a slide-out, awning, stabilizer jack, landing gear, etc from the handheld remote and a corresponding switch (at the command center) at the same time. Doing so can blow one or more fuses on the multi-function receiver.
- Immediately after operation of motor-reversing components using the handheld remote, there is an 8 to 10 second delay where all redundant switches for motor-reversing components are non-functional.
- The “Light” button on the handheld remote will only control the awning light. This circuit does **not** have “soft start” functionality; if turned “ON” with the remote, it must be turned “OFF” with the remote. Likewise, if turned on at the command center panel, it must be turned OFF with the same switch. The handheld remote will enter “Sleep Mode” after 60 seconds of inactivity. Press the “HOME” button to wake it up.

**Awning Operation:** Select the AWNING 1 switch; the screen opens showing the awning function screen. If there are multiple awnings, there will be a selection for each awning at the left of the screen. Select the awning you want to control, then press and hold the right arrow (extend) or left arrow (retract) buttons. Select the HOME icon to return to the previous screen.

**Slide-out Operation:** Slide-out switches may be labeled with the slide name, or a number. A list of the slide-outs on your RV will appear on the left side of the screen. Select the appropriate slide-out switch, which opens the slide-out function screen. Press (and hold) the right arrow button to extend the slide, or the left arrow button to retract it. Repeat this action on the remaining slide-outs. Select the HOME icon to return to the previous screen.

**Stabilizer Jack Operation:** If you have electric stabilizers but not an automatic leveling system on your RV, the remote may have stabilizer selections. There may be (2) stabilizer switches; one for front and one for rear jacks (if so equipped). Selecting a stabilizer switch opens the stabilizer function screen. Press and hold the left arrow (Retract) or the right arrow (Extend) to operate the jacks. Select the HOME icon to return to the previous screen.

### Calibrating the handheld remote

This procedure affects the location on the screen where the device perceives the screen was touched and where it actually “clicks”. Using a stylus will provide the device with a more accurate point and may ease operation. If it is not accurately responding, use the following procedure:

1. Press the “HOME” button (10) times (**Fig 12-A**).
2. Press the (3) crosshair targets as accurately as possible (**Fig 12-B**)
3. Press (3) more confirmation cross hair targets as accurately as possible (**Fig 13-A**).
4. If all crosshairs are tapped accurately the screen will display “Good Stability” (**Fig 14**). Press the “HOME” button to return to the main screen.
5. If the crosshairs are not tapped accurately the screen will display a message stating “Bad Calibration Tap to Restart” (**Fig 15**). If this happens press anywhere on the screen to restart the procedure.



## SECTION 6: ELECTRICAL SYSTEM



### **Batteries**

The remote is equipped with rechargeable batteries along with a charger. There are no user replaceable batteries.

**TESTING THE CAMPSITE POWER CONNECTION**

The campsite 120-volt power receptacle(s) should always be tested for proper functionality prior to plugging the recreation vehicle shore power cord into it.

Campsite 120-volt power receptacles can be tested using a digital multimeter or a dedicated circuit analyzer. Dedicated circuit analyzers plug directly into the campsite power receptacle and minimally test for open neutral, open ground, and correct polarity. **Polarity indicators can be purchased in most electrical and hardware stores.**

**⚠ WARNING**

**Do not hook up the power cord to any receptacle until you have verified proper polarity and grounding.**

**DO NOT** plug the shore power cord into a campsite receptacle(s):

- That has reverse polarity
- With non-functioning ground circuits
- That shows outward signs of heat damage.
- Doing so may result in property damage or serious injury. Plugging the shoreline power cord into an incorrectly wired power source could damage the recreation vehicle electrical system and result in severe or fatal injury. Damage or injury resulting from connection to malfunctioning or improperly wired power sources is not covered by your recreation vehicle warranty.

**DO NOT**

- Do not use any cheater plug, adapter or extension cord to reconfigure incoming AC power or break the continuity of the circuit connected to the grounding pin.
- Do not connect the power cord into an outlet that is not grounded, or adapt the power cord plug to connect it to a receptacle for which it is not designed.
- Do not remove the grounding pin to connect to a non-grounded receptacle. Removal of the ground pin disables an important safety feature designed to prevent shock and electrocution hazards.
- Do not connect the power cord to an extension cord. Use of an improper extension cord will cause overheating of the cord as well as potentially causing premature failure of the AC equipment.
- The power cord must be fully extended when in use and not left coiled in the electrical compartment or on the ground. If the power cord is left coiled, it may potentially create enough heat to melt its protective casing.

It is the responsibility of the owner of the electrical receptacle to ensure that the receptacle is properly wired and grounded. **Reverse polarity and/or improper grounding of your RV can cause property damage or serious personal injury.**

**Connecting the Power Cord**

Always test the external power source (i.e., the campsite power receptacle or electrical box) with a ground monitor before connecting your power cord to it. If the ground monitor indicates 'reverse polarity' or an 'open ground' DO NOT connect the power cord.

To help prevent power surges from damaging the connected loads, please follow these instructions when hooking up to the external power source:

## SECTION 6: ELECTRICAL SYSTEM

1. Turn “off” the load center main 120-volt circuit breaker.
2. Carefully extend the entire length of the power cord (approximately 25’-35’) from the electric cable hatch to the external power source.
3. Plug the power cord into the receptacle. Be sure all the power cord prongs are properly plugged into the receptacle.
4. Return to your RV and turn “on” the load center main circuit breaker.

**The shore line power cord should be unplugged when the recreation vehicle is left unattended. If something would happen to the electrical system, this may help limit potential damage.**

When you are ready to leave, reverse the power cord connection process. Use care to prevent damaging the power cord electrical connection pins when connecting or disconnecting the shore line power cord. Grasp the plug to remove the power cord from the outlet; do not unplug it by pulling on the cord.

### **Maintenance**

Inspect the power cord for cuts, cracks and worn insulation. Have the power cord replaced immediately if these symptoms are noticed.

## **INVERTER (IF SO EQUIPPED)**

A factory installed inverter converts 12-volts DC to useable 120-volts AC and supplies continuous AC power to the appliance plugged into it. It is important that you familiarize yourself with the inverter function and operation. The inverter should be “off” when not in use.

**The factory-installed inverter is not intended for use with medical device(s).**

If your recreation vehicle is equipped with a residential style refrigerator, the inverter may be used to supply the 120-volts AC necessary to power the refrigerator.

### **Maintenance**

*There are no customer serviceable parts inside the inverter case and the manufacturer’s warranty will be void if the case has been removed.* The inverter cooling fins and the cooling fan should be kept clear of any obstructions.

Your RV may have an inverter remote display like this one on the Command Center switch panel. There are power and select buttons, Status/Display indicators and a single line digital alpha numeric display. The display can show measured battery voltage, AC output power, inverter settings and error codes.

POWER button is used to turn the inverter on and off. To turn on the inverter and the LED display press and hold POWER for 1 second until you hear a beep.



**NOTE:** When in *Inverter Mode* you will be able to cycle through Battery Voltage, Inverter Power, inverter settings and error codes. When in *Bypass Mode* you will be able to cycle through Battery Voltage, inverter settings and error codes. Inverter Power will not be available because the inverter is idle.

## SECTION 6: ELECTRICAL SYSTEM

The **STATUS** and **DISPLAY** indicators indicate the inverter status:

- **STATUS & DISPLAY LEDS** - both **GREEN** - Unit is plugged into shore power. The panel is in **Bypass Mode** and will display battery voltage in DC volts.
- **STATUS LED AMBER, DISPLAY LED GREEN** - **Inverter Mode** is active. Inverter is ON and will display battery voltage in DC volts. (Not connected to shore power)
- **STATUS & DISPLAY LEDS** - both **AMBER** - **Inverter Mode** is active. Inverter is ON, pressing the **SELECT** button will display inverter power output. Display shows power output in KW.
- **STATUS LED FLASHES AMBER, DISPLAY LED IS OFF** - If the unit is in **Inverter Mode**, and you plug in shore power, the **STATUS LED** will begin flashing **AMBER** and the unit will switch to **Bypass Mode** within 20 seconds of detecting an AC input.
- If the **STATUS LED** is **RED** and **DISPLAY LED** is **OFF**, the display will show an error code of **E01** through **E12**. This indicates a fault in the inverter circuit that needs attention. Inverter will shut down.

**NOTE:** The power button is **NOT** a power disconnect switch and will not remove DC power from the inverter. Disconnect **ALL** power from the inverter before working on it.

Pressing the **SELECT** button also cycles through inverter settings. Inverter settings can be changed, but **12VDC** must be removed from the **Ignition Start Port** on the back of the inverter. Unplug the **12VDC** wire(s) on the back of the inverter to make changes to inverter settings. Plug **+12VDC** back in after settings are changed. (See photo)

Refer to the Magnum Inverter manufacturers' manual in your warranty packet for further operating instructions, error codes, changing inverter settings and safety information.



### **POWER CONVERTER**

The power converter converts 120-volt AC power to useable 12-volt DC power when the shore power cord is connected to an external power source.

The converter has a built-in protective thermal breaker that will shut it down should overheating occur. Overheating can be caused by operating the converter above its maximum power output for an extended period of time, or by an obstruction to its ventilation air flow. To reduce converter heat build keep unnecessary 12-volt lights and motors turned "off". Keep the converters cooling fins and fan clear of obstructions.

- **USE ONLY A DEEP CYCLE BATTERY FOR RV USE.** Car batteries (CCA rating) are not designed for RV applications. If doing a lot of dry camping use a deep cycle battery rated in amp hours only (NO CCA rating).
- If using multiple batteries they must be the same brand and type. Adding more batteries will provide longer use of DC appliances when not on shore power but may reduce charging efficiency.
- The battery works in conjunction with the converter to supply DC power to the RV. A battery is typically only necessary if you do a lot of dry camping or have slideouts and/or a leveling system.

## SECTION 6: ELECTRICAL SYSTEM

- Reverse polarity fuse provides protection for the converter when a battery is used. If the battery is connected backwards to the fuse board this fuse would blow preventing damage to the converter.
- If your lights are dimming or flickering that usually indicates an overloaded converter. Remove some of the load by turning off DC lights or appliances.
- Fan is controlled by load. It will begin running at 3 to 6 amp DC draw. It increases in speed with a higher load until 14 to 15 amps. Fan is at maximum speed and stays there even with more load. If load drops below 6 amps DC, the fan shuts off.

### **CAUTION**

It is important that the fluid level of any connected batteries be checked on a regular basis. All batteries will “gas” and lose some fluid when continuously connected to any charging source (does not apply to “gel-cell” batteries).

Before checking for converter output voltage, the battery cables must be disconnected at the battery. Make sure the converter is plugged into an AC source (105-132 AC volts). Check the converter output voltage at the battery with a voltmeter. Place the voltmeter probes on the disconnected battery cables. If the voltage reads 13.6VDC with no load, the converter is functioning properly.

If the converter output voltage at the battery reads in the 0.0VDC range, or the battery is not charging, check for:

- An open inline fuse in the battery wire
- An open wire between the converter and the RV battery
- Loose ground connection
- Improper torques

If the converter fuses and AC voltage are good, but the converter output still reads zero volts, the converter is not functioning properly.

Modes of Operation:

**Absorption (Normal) Mode:** 13.6VDC range. Batteries are being charged, just at a slower rate. Converter will not work without AC input.

**Float Trickle Mode:** To get your converter into this mode reduce the load on the system to almost nothing but the battery. Let the system sit for approximately 44 hours.

Converter voltage will drop to 13.2VDC. If the converter sees any load during this period or after it is in Float Mode it will revert back to Absorption (Normal) Mode. 13.6VDC.

**Bulk Mode:** Converter will not jump into the “Bulk Mode” unless the battery is below 50% of charge, or approximately below 13.2VDC output voltage. There is no way to force it to go into Bulk Mode.

**Red LED indicates blown fuse.**

### **Inspection and maintenance**

If the 12-volt power converter is not working (auxiliary battery not being charged) check the reverse polarity fuse(s) located on the end of the converter.

**There are no customer serviceable parts inside the converter case and the manufacturer’s warranty will be void if the case has been removed.** If you have further concerns contact your dealer.

**For detailed information on operation and safety, refer to the manufacturer’s owner’s manual.**



### **Converter with Charge Wizard (if so equipped)**

Some converters may be equipped with a charge wizard. There are (3) possible charging modes; NORMAL, BOOST and STORAGE. The charge wizard will automatically select the best mode to charge your battery. A green LED next to the wizard mode button will indicate by flashes, which mode is currently being used.

**NORMAL MODE:** Green LED flashes once per second; battery is between 50% and 90% charged. Green LED will flash 2-3 times per second; battery is 90% charged. Output voltage is 13.6VDC and the converter is safely completing the charge of the battery.

**BOOST MODE:** Green LED is on solid. Output voltage is 14.4VDC to rapidly charge the battery up to 90% of full charge.

**STORAGE MODE:** Green LED flashes every 6-8 seconds. Output voltage has been reduced to 13.2VDC; the RV battery is fully charged and converter is maintaining the charge.

**MANUAL MODE (Not recommended):** The wizard mode button is used to override the charge wizard. Refer to the converter owner's manual for additional information.

**REVERSE BATTERY PROTECTION:** Reverse polarity fuse(s) provide protection for the converter when a battery is used. If the battery is connected backwards to the fuse board a fuse will blow preventing damage to the converter. Four easily accessible fuses are located next to the wizard button. Replace with fuses of the same type and rating.



**Wizard Button & Reverse Protection Fuses**

## **12-VOLT DC SYSTEM**

The majority of your recreation vehicle lighting is powered by 12-volt electricity. The 12-volt DC system is composed of components that will operate when the following conditions are met:

- Power is supplied by the tow vehicle alternator when the engine is running and the 7-way trailer plug is connected. This powers the RV's running lights, brake lights, turn signals and brakes. In addition, the 7-way trailer plug provides a common ground and a 12-volt charge line to charge the auxiliary battery.
- The converter will supply interior 12-volt DC power when the power cord is plugged into campground power. The converter will also charge the RV battery in most situations. (Refer to *Battery Disconnect*)
- The auxiliary battery powers many interior 12-volt components including the lighting fixtures, water pump, 12-volt motors, 12-volt appliances, etc. It also powers the breakaway switch.

### **12-Volt Fuse Panel**

**⚠ WARNING**

Replacement fuses must be of the same voltage, amperage rating and type. **Never use a higher rated replacement fuse;** doing so may cause a fire by overheating the RV wiring.

The 12-volt fuse panel is labeled to indicate fuse sizes, positions and the components powered. Fuses are located in the load center.

## SECTION 6: ELECTRICAL SYSTEM

### Replacing a Fuse

Before replacing a fuse, always turn off the electrical components protected by it.

1. Disconnect the shore power cord.
2. Turn “off” the inverter (if so equipped).
3. Disconnect the house or auxiliary batteries main negative battery cable.
4. Remove the fuse panel cover to check fuses.
5. Pull the fuse straight out of the fuse block.
6. Insert a new fuse of the same specified voltage, amperage rating and type in the original location.

The fuse panel label should be kept permanently affixed to your recreation vehicle. Fuses will not offer complete protection of the electrical system in the event of a power surge or spike.

### 12-Volt DC Outlet

There may be one or more 12-volt DC power outlets in your recreation vehicle. When the 12-volt DC outlet is used as a power source for an electric appliance, make sure the appliance operates on 12-volt DC power and that it consumes less than 60 watts (5 amps) of power.

### **WARNING**

Keep the protective dust cap on the 12-volt DC outlet when not in use to prevent ingestion of foreign material and potential short circuit conditions.

## AUXILIARY BATTERY (CUSTOMER SUPPLIED)

### **WARNING**

- ❑ **Do not store anything inside the battery compartment(s)** or near the batteries that could touch the battery or battery cable terminals. Contact with the battery or battery cable terminals could cause an electrical short circuit, discharge the batteries, or start an electrical fire.
- ❑ **Keep sparks, cigarettes and flames away from the batteries as the hydrogen gas they create may explode.** Do not connect a booster battery or other power source that outputs more than 14.2-volts DC to the RV batteries. Use adequate ventilation when charging or using batteries in an enclosed space. Remove metal jewelry and always wear eye protection when working around batteries.
- ❑ **Do not allow battery electrolyte (acid) to come into contact with skin, eyes, fabric or painted surfaces.** Electrolyte is a sulfuric acid solution that could cause serious personal injury or property damage. If your hands, eyes, clothes or the painted surface of your RV are exposed to electrolyte, flush the exposed area thoroughly with water. If electrolyte gets in your eyes, immediately flush them thoroughly with water and get prompt medical attention.

The combined 12-volt DC loads in your recreation vehicle become more than the converter can produce. This demand can be met by using an auxiliary battery for a limited period of time. The 12-volt system is designed for usage with a Group 27, deep cycle battery.

### **Dry Camping**

The auxiliary battery should be fully charged prior to dry camping. If the auxiliary battery is not being recharged and power is being drawn from it, it will eventually discharge. A battery will discharge at a faster rate as its energy level becomes depleted. Plan your electrical usage accordingly. You can test the auxiliary battery voltage using a volt-ohm meter (customer supplied).

A fully charged auxiliary battery will read 12.7 volts DC and 1.265 specific gravity at 80°F (32°C). The auxiliary battery is considered discharged at 11.89 volts, and dead at 11.65 volts. If the voltage drops below those levels, irreversible damage can occur. Typically, a deep cycle battery has an amp-hour rating of 75-100 amps.

If you run the furnace and refrigerator simultaneously, you will be using approximately (12.0 + 3.0) 15.0 amps per hour. This does not include any 12-volt lights, or any other 12-volt component. If the furnace and refrigerator in this example operated constantly, a 75 amp-hour battery would become fully discharged in 5 hours.

The auxiliary battery should be installed in parallel with the battery in your tow vehicle. When the 7-way trailer plug is connected, both batteries power the RV. Do not allow it to discharge your tow vehicle battery below the level required to start the engine. To prevent this from occurring, disconnect the 7-way trailer plug or install a battery isolator. When the tow vehicle engine is operating with the RV connected, the tow vehicle charging system will charge both batteries.

### **Replacement and Maintenance**

Some equipment in your RV will draw small amounts of current even when turned OFF. To prevent the auxiliary battery from being discharged when your RV is not connected to shore line power, disconnect the auxiliary battery negative cable at the battery. During storage, it is important to check the voltage monthly and recharge the auxiliary battery as needed. If you remove the auxiliary battery from your RV, store it in a dry, cool area per the manufacturer's instructions.

**When it is time to replace the auxiliary battery, Group 27 or Group 31 true deep cycle batteries are recommended to increase run time of electrical components while dry camping (operating solely on battery power).**

Do not reverse the positive and negative battery cables (doing so will blow the reverse polarity fuse(s) that protect the converter).

### **For more information**

Please contact the battery manufacturer for additional information on the auxiliary batteries.

### **Battery Isolator For Your Tow Vehicle (customer supplied)**

You may want to consider the installation of a battery isolator on your tow vehicle as a convenience feature:

- It receives current from the tow vehicle alternator and controls distribution of energy to both the RV auxiliary battery and the tow vehicle battery.
- It serves as a check valve to prevent energy from being drawn from your tow vehicle chassis battery (so you can start your tow vehicle engine).

Your dealer can assist you with the selection, purchase and installation.

### **Battery Disconnect Switch (if so equipped)**

The Battery Disconnect switch is typically located in an enclosed exterior compartment. The style of the disconnect switch may vary per model. This switch does not shut off all power, but only shuts off the 12VDC power to the main 12V fuse panel, and the interior of the vehicle. Batteries can still be trickle charged by the converter, and there will still be power to some devices.

## **SECTION 6: ELECTRICAL SYSTEM**

### **Rotating Dial Disconnect Switch**

When this switch is ON, there will be a green area showing a “1” along the top of the switch. To turn the switch OFF, turn it counter-clockwise until you see the red area along the left side of the switch showing a “0” (zero).

### **Lever Type Disconnect Switch**

To operate this switch, turn the lever counter-clockwise to turn off all 12VDC power to the fuse panel in the RV. The lever can be removed and is equipped with a lanyard to keep the key from getting lost.

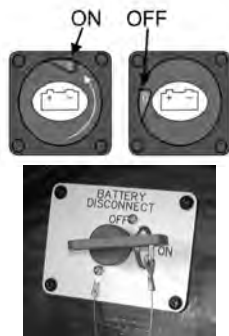

**Battery Disconnect Switches**  
(switch appearance may vary by model)

## **LOAD CENTER**

The Load Center contains 12VDC fuses and 120VAC circuit breakers for almost all of the electrical appliances and circuits in the RV. The 120V main breaker may be located in this panel and will turn off all 120-volt power to the RV. Locations will vary by model. Refer to the diagram inside the load center for specific fuse assignments. Not all load centers will include a main breaker.

Motorhomes may have separate small panels for breakers and fuses. They are normally located in close proximity to each other typically in the bed platform. The converter is also mounted separately (typically under the bed platform).

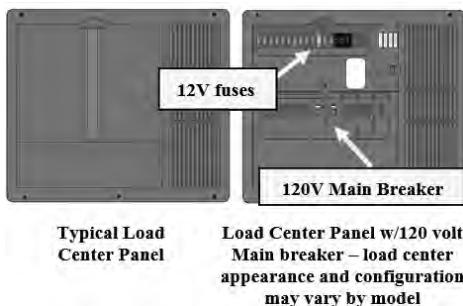

## **120-VOLT CIRCUIT BREAKERS**

The 120-volt AC circuit breakers located inside the load center protect all 120-volt wiring and components from circuit overloads and short circuits. Should a circuit overload or short circuit occur the circuit breaker protecting the affected circuit will “trip” preventing the flow of electricity through that circuit.

If a circuit breaker trips, shut “off” the appliance on that circuit (i.e., power converter etc.) and allow the circuit breaker to cool down for a brief period of time. After it cools down, reset the circuit breaker by moving its lever “off” and then back to the “on” position. If the circuit breaker re-trips or frequently trips, contact your dealer to have the electrical problem diagnosed and repaired.

A circuit breaker identification label is permanently attached to the inside surface of the 120-volt Load Center.



**NOTE:** Load Centers may not always include a main circuit breaker.

**⚠ CAUTION**

Circuit breakers and fuses will not offer complete protection of the electrical system in the event of power surge or voltage spike.

**Replacement**

Only replace circuit breakers with those of the same specified type, voltage, and current rating. **Never replace a circuit breaker with one listed at a higher amperage rating.** Please contact your dealer for repair assistance when replacing circuit breakers.

**⚠ WARNING**

Replacement circuit breakers must be of the same voltage, amperage rating and type. Never use a higher rated replacement circuit breaker; doing so may cause a fire by overheating the RV wiring.

**Maintenance**

At the beginning of camping season, inspect the circuit breakers and replace as needed. Test by turning each circuit breaker “off” and back “on”. Circuit breakers are wearable parts and must be replaced as needed, as part of your RV maintenance. If you have any questions, consult your dealer.

A label is provided to explain the function of every 120-volt circuit breaker. This label is located on or near the appropriate load center or sub-panel and must remain permanently affixed to the recreation vehicle.

## SECTION 6: ELECTRICAL SYSTEM

### ***APPROXIMATE ELECTRICAL LOAD RATINGS***

<b>12 VOLT SYSTEM</b>	
Exterior Entertainment Center	5-7 AMPS
Fan	1.5 AMPS
Furnace	12.0 AMPS
Generator Start	95.0 AMPS*
Illuminated Switch	.125 AMP
Inverter	variable
Leveling System	95.0 AMPS*
LP Detector	.125 AMP
Light; Halogen	1.7 AMPS
Light; Vanity	4.2 AMPS
Lights; Aisle	1.0 AMP
Lights; Baggage Compartment / Shower	1.4 AMPS
Lights; Decorative Wall / Map / Porch	1.5 AMPS
Lights; Fluorescent Double -12"	2.0 AMPS
Lights; Fluorescent Double -18"	2.5 AMPS
Power Awning	10.0 AMPS
Power Vent	5.0 AMPS
Refrigerator	3.0 AMPS
Step Cover	10.0 AMPS
TV Plate/Antenna Booster	1.0 AMP
Water Heater	6.0 AMPS
Water Pump	7.0 AMPS

\*Momentary Load

12 Volts: Labeled watts divided by 12 = Power consumed in AMPS

<b>120 VOLT SYSTEM</b>	
Air Conditioner	18 AMPS
Coffee Maker	6-12 AMPS
Converter (each)	8 AMPS
DVD System	3 AMPS
Fireplace	12 AMPS
Hair Dryer or Curling Iron	10-14 AMPS
Microwave	12 AMPS
Refrigerator	6 AMPS
Satellite Receiver	2 AMPS
TV	2-4 AMPS
Vacuum Cleaner	8 AMPS
Washer/Dryer	12 AMPS
Water Heater	12 AMPS

120 Volts: Labeled watts divided by 120 = Power consumed in AMPS

**120-VOLT (30 AMP) AC SYSTEM (IF SO EQUIPPED)**

The 30 amp 120-volt 60hz AC electrical system is designed to operate on 1 leg of 120-volt power at a maximum current flow of 30 amperes.

Exposure to voltages higher or lower than a nominal 120-volts will damage or shorten the service life of the electrical system and appliances. The 30 amp 120-volt 60hz AC electrical system can be powered by the 120-volt 60hz utilities found in RV campgrounds or by 120-volt 60hz generator power.

The following electrical components will only operate when your recreation vehicle is connected to shore or generator power: 120 to 12-volt power converter, air conditioner, refrigerator, microwave oven, television(s), home theater system(s), electric water heater, washer, dryer, fireplace, and appliances plugged into convenience receptacles.

** WARNING**

- Make certain the external power source you connect the power cord to is a properly wired **30 amp NEMA TT-30** RV receptacle and not 240-volt AC. **PLUG INTO 30-AMP SERVICE ONLY.**
- Circuit breakers and fuses will not offer complete protection of the electrical system in the event of power surge or voltage spike.

**30-amp Power Cord (if so equipped)**

** WARNING**

- Do not hook up the power cord to any receptacle **until** you have verified proper polarity and grounding. Polarity indicators can be purchased in most electrical and hardware stores.
- Do not use any cheater plug, adapter or extension cord to reconfigure incoming AC power or break the continuity of the circuit connected to the grounding pin.
- Do not connect the power cord into an outlet that is not grounded, or adapt the power cord plug to connect it to a receptacle for which it is not designed.
- Do not remove the grounding pin to connect to a non-grounded receptacle. Removal of the ground pin disables an important safety feature designed to prevent shock and electrocution hazards.
- Do not connect the power cord to an extension cord. Use of an improper extension cord will cause overheating of the cord as well as potentially causing premature failure of the AC equipment.

It is the responsibility of the owner of the electrical receptacle to ensure that the receptacle is properly wired and grounded. Reverse polarity and/or improper grounding of your recreation vehicle can cause personal injury or death.

The 30-amp external utility power cord is commonly referred to as the “shore” power cord. It is designed to mate and properly function with 30-amp “shore” power receptacles available at most campgrounds.

The shore power cord is designed to continuously carry the 30-amp current flow required to power each leg of the electrical system. It also creates a critical ground connection between the vehicle electrical system and the campground shore power receptacle.

## SECTION 6: ELECTRICAL SYSTEM

Always test the external power source (i.e., the campsite power receptacle or electrical box) with a ground monitor before connecting your power cord to it. If the ground monitor indicates 'reverse polarity' or an 'open ground' **DO NOT** connect the power cord.

Regularly inspect the shore power cord for cuts, cracks, worn insulation and other damage. Have the power cord replaced immediately if problems exist.

### **Calculating 30 AMP Electrical Load (if so equipped)**

When connecting appliances to the electrical system, 120-volt power usage is limited to a total of 30 amps. Operating appliances collectively places an added load on your 120-volt electrical system.

An unintentional "trip" of a circuit breaker may occur if you overload the recreation vehicle and/or campground electrical system. The amperage rating of individual appliances can be calculated by dividing appliance wattage consumed (normally listed on the appliance) by nominal design voltage (120 for a 120-volt appliance). For example: 1200 watts divided by 120-volts equals 10 amps.

### **120-VOLT (50 AMP) AC SYSTEM (IF SO EQUIPPED)**

The 50 amp 120-volt 60hz AC electrical system can be powered by an outside 120/240-volt 60hz utility service like those commonly found in campgrounds or by 120/240-volt 60hz generator power. The entire system is designed to operate on 2 legs of 120-volt power at a maximum current flow of 50 amperes per leg.

Exposure to voltages higher or lower than a nominal 120-volts, will damage or shorten the service life of the electrical system and appliances. The 50 amp 120-volt 60hz AC electrical system can be powered by an outside 120/240-volt 60hz utility service like those commonly found in campgrounds or by 120/240-volt 60hz generator power.

The following electrical components will only operate when connected to 120-volt power: air conditioner(s), refrigerator, microwave oven, television(s), home theater system(s), water heater, washer, dryer, fireplace, electric stove, and appliances plugged into convenience receptacles.

## **WARNING**

- Circuit breakers and fuses will not offer complete protection of the electrical system in the event of power surge or voltage spike.
- Make certain the external power source you connect the power cord to is a properly wired **50 amp NEMA 14-50** RV receptacle and not 240 volt AC.
- PLUG INTO 50-AMP SERVICE ONLY.**



**50-AMP Power Cord (if so equipped)**

** WARNING**

- Do not hook up the power cord to any receptacle until you have verified proper polarity and grounding. Polarity indicators can be purchased in most electrical and hardware stores.
- Do not use any cheater plug, adapter or extension cord to reconfigure incoming AC power or break the continuity of the circuit connected to the grounding pin.
- Do not connect the power cord into an outlet that is not grounded, or adapt the power cord plug to connect it to a receptacle for which it is not designed.
- Do not remove the grounding pin to connect to a non-grounded receptacle. Removal of the ground pin disables an important safety feature designed to prevent shock and electrocution hazards.
- Do not connect the power cord to an extension cord. Use of an improper extension cord will cause overheating of the cord as well as potentially causing premature failure of the AC equipment.

It is the responsibility of the owner of the electrical receptacle to ensure that the receptacle is properly wired and grounded. Reverse polarity and/or improper grounding of your recreation vehicle can cause personal injury or death.

The 50-amp external utility power cord is commonly referred to as the “shore” power cord. It is designed to mate and properly function with 50-amp “shore” power receptacles available at most campgrounds.

The shore power cord is designed to continuously carry the 50-amp current flow required to power each leg of the electrical system. It also creates a critical ground connection between the vehicle electrical system and the campground shore power receptacle.

Always test the external power source (i.e., the campsite power receptacle or electrical box) with a ground monitor before connecting your power cord to it. If the ground monitor indicates ‘reverse polarity’ or an ‘open ground’ **DO NOT connect the power cord.**

Regularly inspect the shore power cord for cuts, cracks, worn insulation and other damage. Have the power cord replaced immediately if problems exist.

**Calculating 50 AMP Electrical Load (if so equipped)**

When connecting appliances to the electrical system, remember that 120-volt power usage is limited to 50 amps per electrical system leg for a total of 100 amps. Each operating appliance collectively places an added load on your 120-volt electrical system.

An unintentional “trip” of a circuit breaker may occur if you overload the recreation vehicle and/or campground electrical system. The amperage rating of individual appliances can be calculated by dividing appliance wattage consumed (normally listed on the appliance) by nominal design voltage (120 for a 120-volt appliance). For example: 1200 watts divided by 120-volts equals 10 amps.

## **SECTION 6: ELECTRICAL SYSTEM**

### ***SOLAR PREP (IF SO EQUIPPED)***

---

Your recreation vehicle may be wired with a (exterior) plug in that will allow the batteries to be trickle charged using a free standing solar panel. In most models, the solar panel kit is a customer purchased and installed option. The solar plug location will vary by model, but may be located on the exterior sidewall, on the A-frame of the RV, in the outside utility center, or mounted up on the roof.

There are capped off wires located in the area of the battery. These wires are the battery charging wires. Once these wires are properly connected to your battery, you will then be able to plug the solar panel into the charging port.

When the system is connected properly, the solar panel will supply power to the battery, the battery will supply power to the converter, and the converter will supply power to all the 12V systems as needed.



**Solar Plug**

### ***REPLACING LIGHT BULBS***

---

Before replacing a bulb, be sure the light is off. Do not touch the glass part of the new bulb with your bare fingers. The skin oil left on the glass will evaporate when the bulb gets hot, the vapor will condense on the reflector and it will dim the surface.

Replacement light bulbs must be of the type, voltage and wattage listed on the lamp fixture. Use of incorrectly sized bulbs can overload lamp circuits and may create a fire hazard by overheating the fixture.

**EXHAUST GAS FUMES**

**⚠ WARNING**

- Avoid inhaling exhaust gases as they contain carbon monoxide, which is a potentially toxic gas that is colorless and odorless.
- If you are in a recreation vehicle with either a nearby tow vehicle engine running or the generator (if so equipped) running there is a potential for exhaust fumes to filter back into the recreation vehicle.

To avoid breathing exhaust gases, follow these precautions:

- Always shut OFF the tow vehicle engine, generator engine (if applicable), etc., while refueling.
- Do not run the tow vehicle engine, generator engine (if applicable), etc., in confined areas, such as a closed garage, any longer than needed to move your RV in or out of the area.
- Windows should be closed while driving or running the generator (if so equipped) to avoid drawing dangerous exhaust gases into the RV.
- If you suspect that exhaust fumes are entering the RV have the cause determined and corrected as soon as possible.

The best protection against carbon monoxide entry into the RV is a properly maintained ventilation system and an active carbon monoxide detector. To allow for proper operation of the RV ventilation system, keep the ventilation inlet grill(s) clear of snow, leaves or other obstructions at all times.

See the *Occupant Safety* section of this manual for additional information on carbon monoxide safety.

**PROPANE GAS SYSTEM**

Propane or LP (liquefied petroleum) gas is an efficient form of energy when proper handling and safety precautions are observed. The propane system in your recreation vehicle furnishes the fuel for cooking, heating, hot water and can be an alternative energy source for refrigeration

Propane is heavier than air; and tends to flow to lower areas and will sometimes pocket in these low areas, such as the floor. Your recreation vehicle is equipped with a propane alarm (refer to the Safety Precaution section, Combination Carbon Monoxide (CO)/Propane Alarm).

**⚠ WARNING**

Propane cylinders should not be placed or stored inside RV. LP-gas cylinders are equipped with safety devices that relieve pressure by discharging gas into the atmosphere.

The propane fuel system is comprised of numerous components such as the propane container, hoses, the propane gas regulator, piping and copper tubing to each appliance.

Although your recreation vehicle has been carefully tested at the factory, and by your selling dealer for leakage, travel vibrations can loosen fittings. Have the propane system checked at all connections soon after the purchase of your recreation vehicle, and after the initial filling of the propane tanks.

## SECTION 7: FUEL & PROPANE SYSTEM

Continued periodic checks of the propane system at 5,000 miles of travel (or at least once a year), by a qualified propane service representative as part of your normal maintenance is recommended. Hand tighten the LP gas system valves only, do not use a wrench or pliers as over tightening may damage the valve seals and cause them to leak.



**NOTE:** All propane lines have been checked with air pressure at the time of manufacture. Dealers are required to recheck and adjust pressure before retail delivery.

### Propane Gas Container

## **WARNING**

- DOT propane cylinders must be transported and stored in an upright position so the pressure relief device will function properly.** Laying a DOT propane cylinder on its side may potentially create a very dangerous situation.
- The pigtail hose must be installed to avoid tension or pulling stress at either end of the hose.** Keep the pigtail hose away from sharp edges of the cylinder collar, rigid corners, walls, doors or other compartment structures including the cover.
- Before entering a propane or fuel service station make sure all pilot lights are extinguished.** Shut off gas to all appliances by closing the propane gas main shut off valve. Always shut OFF any engine before refueling. Do not smoke and do not operate other ignition sources while refueling.
- If you suspect your propane container has been overfilled, contact your dealer or a qualified propane technician for assistance immediately.** Do not attempt to service a propane container overfill yourself.

Propane “container” is a general all-inclusive term used to describe a vessel that is used for storage and delivery of propane gas.

The most common of these are:

DOT (Department of Transportation) cylinders are transportable and are commonly used on recreation vehicles. The capacity of DOT propane cylinders is expressed in pounds. DOT propane cylinders are required to be removed from the RV for filling and must be filled by weight by a qualified propane facility. DOT Propane cylinders are equipped with an OPD (over fill protection device) designed to reduce the potential of overfilling. DOT propane cylinders are also equipped with an ACME service valve that is for connection of the TYPE 1 ACME pigtail hose assembly to the RV two-stage regulator.

The TYPE 1 ACME pigtail hose assembly is a wrench less, right hand threaded connector that features a thermally sensitive sleeve and excess flow device. Max output is 200,000 BTU/hr. It is used to connect propane cylinders to regulators, hoses and other fittings. It is not for use on gas grills and other low pressure devices. DOT cylinders equipped with an OPD and ACME type 1 service valve are identified by the triangular service valve knob.

DOT cylinders are typically marked with “top” or an arrow to indicate the correct orientation of the cylinder(s). Do not mount, store or transport any cylinder other than the in proper position indicated.

## SECTION 7: FUEL & PROPANE SYSTEM

Be sure to securely re-install DOT cylinder(s) after they have been removed for filling or replacement. Always close the service valve and install a dust cap or plug when transporting or storing disconnected containers whether full or empty.

ASME tanks are permanently mounted to the RV and are commonly used on RV motorhomes. The capacity of ASME tanks is expressed in gallons. ASME tanks are filled while the tank is attached to the motorhome by a qualified propane facility. ASME tanks are equipped with an automatic stop fill valve designed to reduce the potential of overfilling. ASME propane tanks are also equipped with a P.O.L. service valve that is for connection of the supply hose with a left hand threaded brass P.O.L. fitting from the tank service valve to the two-stage regulator. Not for use on gas grills and other low pressure devices.



**NOTE:** Tanks are to be installed, fueled and maintained in accordance to State and Local codes, rules, regulations or laws.

Propane is a true gas compressed into a liquid form. As the fuel is released from the container, it changes to vapor which is then used for the operation of the appliances. Propane will not run through the appliances in the liquid state.

Propane expands 1½ percent for every ten degrees of increase in temperature. It is imperative to leave sufficient space inside the container to allow for natural expansion of gas during warmer weather.

The main shut off valve must be kept closed at all times unless you are using the propane system or filling the propane cylinder. When the cylinder is disconnected from the hose, install the valve cover that is attached to the container.

Close the propane cylinder main shut off valve by hand tightening only. Use of tools createto over tighten the valve (damaging the interior seals on the cylinder valve seat). If this type of damage occurs, the cylinder will not close properly.

This propane label should be kept permanently affixed to your RV.

### Servicing or Filling

Have the recreation vehicle checked for leaks at the connections on the propane system soon after the purchase and the initial filling of each propane cylinder.

When you have a new cylinder filled for the first time, make sure your propane supplier purges your new cylinder of trapped air. Otherwise, an improper mixture of gas and air will make it impossible to light your propane appliances.

No one should be inside the RV and only the qualified propane service technician should be near the RV while the propane tank is being filled. The new propane container must be carefully purged for best performance and must **NEVER BE OVER-FILLED**. This “shut off for re-fueling” label should be kept permanently affixed to your RV.

**WARNING**  
THIS SYSTEM IS DESIGNED FOR USE WITH PROPANE ONLY.  
DO NOT CONNECT NATURAL GAS TO THIS SYSTEM.

**BEFORE TURNING ON PROPANE:**

- BE SURE CERTAIN APPLIANCES ARE IDENTIFIED FOR PROPANE AND ARE EQUIPPED WITH CORRECT BURNER ORNIBES.
- MAKE CERTAIN ALL PROPANE CONNECTIONS ARE TIGHT BY TESTING WITH SOAPY WATER. ALL APPLIANCE VALVES ARE TURNED OFF, AND ANY UNCONNECTED GUILTS ARE CAPPED.

**AFTER TURNING ON PROPANE:**

- LEAVE ALL VALVES
- ALL CONNECTIONS, INCLUDING THOSE AT THE ADJUSTABLE REGULATORS AND CONTROLS, SHOULD BE LEAK TESTED PERIODICALLY WITH SOAPY WATER BY THE OCCUPANT. NEVER USE A LIGHTED MATCH OR OTHER FLAME WHEN CHECKING FOR LEAKS.
- DO NOT LEAVE SYSTEM TURNED ON OR CONTAINERS CONNECTED UNTIL THE SYSTEM HAS BEEN PROVEN TO BE FREE OF ANY LEAKS.
- COOKING APPLIANCES SHOULD NOT BE USED FOR SPACE HEATING.
- WHEN THE CONTAINERS ARE DISCONNECTED, THE PROPANE SUPPLY LINE SHOULD BE CAPPED OR PLUGGED.

**AVERTISSEMENT**  
CETTE INSTALLATION EST CONÇUE POUR LE PROPANE SEULEMENT.  
NE PAS L'ALIMENTER EN GAZ NATUREL.

**AVANT LA MISE EN SERVICE:**

- ASSURER QUE LES APPAREILS SONT CERTIFIES POUR LE PROPANE ET MUNIS DE BRÛLEURS APPROPRIÉS.
- VÉRIFIER L'ÉTANCHÉITÉ DE TOUTES LES RACCORDEMENTS AU PROPANE. LA MÉTHODE DE TOUTES LES VANNES DE TOUTES LES APPAREILS ET L'ÉTOFFAGE DE TOUTES LES SOUPLES NON RACCORDEES.

**APRÈS LA MISE EN SERVICE:**

- LAISSER TOUTES LES VANNES OUVERTES.
- L'OCCUPANT DOIT PÉRIODIQUÉMENT L'ÉTANCHÉITÉ DE TOUTES LES RACCORDEMENTS, Y COMPRIS CEUX AUX APPAREILS AUX DÉTACHES ET AUX BOUTEILLES, EN Y AJOUTANT DE L'EAU SAVONNEUSE. NE PAS SE SERVIR D'UNE ALLUMÈTE OU AUTRE FLAMME POUR LA DÉTECTION DES FUITES.
- NE PAS LAISSER L'ALIMENTATION SUIVRE, N'EST PAS RACCORDEE AUCUN ÉLÉMENT COMPLET L'ÉTOFFAGE DÉTACHÉ AU PROPANE DE L'INSTALLATION.
- LES APPAREILS DE CUISSON NE DOIVENT PAS ÊTRE UTILISÉS POUR LE CHAUFFAGE DES LOCAUX.
- LORSQUE LES RÉCIPENTS SONT DÉCONNECTÉS, L'ALIMENTATION DE PROPANE DOIT ÊTRE COUVERTE OU SOUVERE.

JA 105

“Use propane only” Label  
(Canada only)

(label appearance may  
not be exact)

**▲ DANGER**  
ALL PILOT LIGHTS, APPLIANCES  
AND THEIR IGNITORS (SEE  
OPERATING INSTRUCTIONS) SHALL  
BE TURNED OFF BEFORE REFUELLING  
OF MOTOR FUEL TANKS AND/OR  
PROPANE CONTAINERS.  
FAILURE TO COMPLY COULD RESULT  
IN DEATH OR SERIOUS INJURY. 4007

“Shut off for re-fueling”  
Label

(label appearance may  
not be exact)

## SECTION 7: FUEL & PROPANE SYSTEM

The position of the propane container(s) and the hoses are critical to proper operation and propane flow. Follow these instructions to make sure your propane container(s) are connected properly.

### LP Gas Container Overfill

Never allow your propane tank to be filled above the maximum safe level as indicated by the fixed liquid level gauge. Do not allow the visible gauge to be used for filling. Overfilling the propane container above the liquid capacity indicated on the container, could allow liquid propane to enter the system that is designed for vapor only creating a hazardous condition.

This label should be kept permanently affixed to your RV.

Refer to your Warranty Packet for more information on the LP gas system components.

### Maintenance

Propane gas is normally non-corrosive - you need not worry about the inside of your container. However, the outside should be kept free from rust by a periodic coat of paint in a light reflective color. Rust, scratches and/or dents can affect the safety of the cylinder. Inspect the cylinder at regular intervals.

If a problem, have it evaluated by a qualified technician and discard it. DOT requires that a visual inspection be made prior to each filling.

Any cylinder that has been exposed to fire, leaks or seems damaged should not be refilled.

Do not attempt to repair any containers, container valves, regulator or appliances by yourself. Use only trained certified propane gas service technicians to perform repairs.

### Propane Cylinder Recertification

DOT cylinders may only be used for 12 years after their manufacture date (the number of years for certification may vary in your area). After that, the cylinders must be "recertified" which provides another five years of use.

The cylinders can be recertified every five years thereafter. Federal DOT (Department of Transportation) regulations require periodic inspections and re-qualifications of the propane cylinders. DO NOT USE damaged or rusted containers.

Verify with your local propane dealer that all required inspections and certifications have been completed on the propane cylinder within the correct time period before refilling the cylinder. Have the LP system checked for leakage each time a cylinder is refilled or after any part of the propane system has been disconnected.

### Hoses, Pipes, Tubes and Fittings

The hoses, pipes, tubes and fittings used in your propane system are designed to withstand pressures exceeding those of the propane system. However, because environment and time can both contribute to the deterioration of these components, they must be inspected for wear at regular intervals.

Be sure to inspect the hose before each season and when having the tank refilled. Look for signs of deterioration such as cracks or loss of flexibility. When replacing the hose or other propane components, make sure to always replace them with components of the same type and rating (check with your dealer).

Fittings are used to connect the various system components to each other. The P.O.L. fitting at the end of the propane supply hose is made of brass so that pipe sealants are not necessary to prevent leaking.

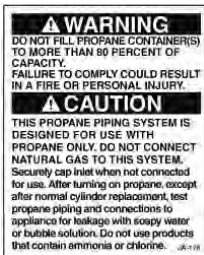

**“Do not fill to more than 80%” Label (label appearance may not be exact)**

It also has a left-handed thread, which means that it is turned clockwise to remove, and counter-clockwise to tighten. The P.O.L. fitting has been designed to help restrict the flow of LP gas in the event of a regulator failure or hose malfunction.

### **Propane Regulator**

#### **WARNING**

Propane regulators must always be installed with the regulator vent facing downward. Regulators that are not located in baggage compartments have been equipped with a protective cover. Make sure the regulator vent faces downward and (if applicable) the cover is in place to minimize vent blockage that could result in excessive gas pressure causing fire or explosion.

### **Single stage regulator**

Some models are equipped with a single stage regulator.

### **Two stage regulator**

The two-stage regulator has the only moving components in the propane system. Its sole function is to reduce the pressure from the propane containers to a safe and consistent low operating pressure. The first stage reduces the container pressure to 10-13 lbs. The second stage reduces the 10-13 lbs. of pressure further to an operating pressure of 11" W.C. (water column) or 6.35 oz. of outlet pressure to your appliances.

The second stage is adjustable and will need to be adjusted by your dealer or qualified propane service technician for optimum performance (this adjustment should always be made with a properly calibrated manometer).

If the pressure is too high, it affects performance and safety; if the pressure is too low, your appliances will not operate correctly.

If the pressure is too high, it affects performance and safety; if the pressure is too low, your appliances will not operate correctly.

If your recreation vehicle is equipped with the "automatic" two-stage regulator, with both cylinders full of propane, turn the lever on the regulator towards the cylinder you wish to use first. This will now be the "supply" cylinder and the other the "reserve". Slowly open both cylinder valves. The indicator on top of the regulator will turn bright green. When the cylinder becomes empty, the indicator will change to bright orange. Now turn the regulator lever to the side of the "reserve" cylinder and the green signal should return. You may now remove the empty cylinder to have it refilled without interrupting the flow from the full bottle. After filling the cylinder, connect the pigtail hose and slowly open the bottle valve.

### **PROPANE USE AND SAFETY**

Propane is a colorless and odorless gas that, in the liquefied state, resembles water. An odorant (usually a sulfur compound) is added as a warning agent. If you smell propane within the vehicle, quickly and carefully perform the procedure listed on the propane system label. This label has been placed in the vehicle near the range, for models equipped with a propane system. When propane container is low, occasionally there may be a concentration of an onion or garlic-like odor, which can be mistaken for a propane gas leak. After the propane container has been refueled, the odor will usually disappear. If not, turn off the valve(s) and have the propane system inspected by your dealer or qualified propane service representative.

#### **Propane Leak Test**

Leaks may be found easily with a soapy water solution.

Do not use a solution containing ammonia or chlorine when locating leaks. These products are corrosive to copper gas lines and brass fittings, which could result in deterioration of the copper and brass components.

Apply the soapy solution to the outside of the gas piping fittings. If a leak is present, the soapy solution will “bubble” at the leak point. If a leak is indicated, shut off the propane system valve(s) and contact your dealer or qualified propane service representative immediately.

### **⚠ DANGER**

#### **IF YOU SMELL PROPANE**

1. Extinguish any open flames, pilot lights and all smoking materials.
2. Shut off the propane supply at the container valve(s) or propane supply connection.
3. Do not touch electrical switches.
4. Open doors and other ventilating openings.
5. Leave the area until odor clears.
6. Have the propane system checked and leakage source corrected before using again.

Ignition of flammable vapors could lead to a fire or explosion and result death of serious injury.

#### **Propane System Label**

### **⚠ DANGER**

**Never use an open flame to test for a propane leak.** Do not check for leaks using products that contain ammonia or chlorine; these products can cause cracks to form on the metal tubing and brass fittings

#### **Using the Propane System**

Use the following steps for propane operation:

1. Close ALL burner valves, controls and pilot light valves.
2. Open the main valve in the propane tank slowly to avoid a fast rush of propane vapor through the excess flow valve causing propane “freeze-up.” Should you experience propane “freeze-up,” close the main valve and wait 15 minutes before trying again.
3. Listen carefully as propane begins to flow. If a hissing noise is heard for more than one or two seconds, close the main valve and contact your recreation vehicle dealer to have the propane system tested.
4. **Light the appliances as needed and directed in the appropriate appliance manufacturer’s owner manual located in the Warranty Packet.**

Keep the propane container valves closed at all times unless you are using the propane gas system or are having the propane container filled.

**Make sure that you read and fully understand ALL safety requirements for handling and operation of the propane system.**

The propane system must be handled with care. If you have any questions or concerns, consult with your dealer and/or the specific appliance manufacturer.



## SECTION 7: FUEL & PROPANE SYSTEM

If you have double cylinders on your recreation vehicle, use only one at a time. Otherwise, the propane supply will be drawn equally from both cylinders until the supply has been totally exhausted. Using one cylinder until it is empty, then using the second cylinder will allow you to fill the empty cylinder at your convenience without running totally out of propane.

### Cooking With Propane Gas

<b>⚠ WARNING</b>
<ul style="list-style-type: none"><li><input type="checkbox"/> Do not turn gas range burner controls to ON and allow gas to escape before lighting.</li><li><input type="checkbox"/> Do not use portable fuel burning equipment (i.e., wood and charcoal grills or stoves) inside the recreation vehicle.</li></ul>

Unlike homes, the amount of oxygen supply is limited due to the size of the recreation vehicle. Proper ventilation when using the cooking appliance(s) will help you avoid the danger of asphyxiation.

**It is especially important that cooking appliances not be used for comfort heating, as the danger of asphyxiation is greater when the appliance is used for long periods of time. FAILURE TO COMPLY MAY RESULT IN DEATH OR SERIOUS INJURY.**

These warning labels are located in the cooking area to remind the user to provide an adequate supply of fresh air for combustion.

<b>⚠ DANGER</b>
Do not use gas cooking appliances for comfort heating. Can lead to carbon monoxide poisoning, which can lead to death or serious injury.
<b>⚠ WARNING</b>
Gas cooking appliances need fresh air for safe operation. Before operating: Open vents or windows slightly or turn on exhaust fans prior to using cooking appliance. Gas flames consume oxygen, which should be replaced to ensure proper combustion. Improper use can result in death or serious injury.

### Cooking / Comfort Heating Label

TO ENSURE A SUPPLY OF FRESH AIR TO OCCUPANTS, OPEN VENTILATORS WHEN FUEL BURNING RANGE, FUEL BURNING CARRY-ON APPLIANCE, AND/OR FUEL BURNING LIGHTS ARE IN OPERATION. COOKING APPLIANCES SHOULD NOT BE USED FOR SPACE HEATING PURPOSES.	DE MANIÈRE À ASSURER UNE ALIMENTATION EN AIR FRAIS AUX OCCUPANTS, OUVRIR LES VENTILATEURS LORSQUE LA CUISINIÈRE, LES APPAREILS DE CHAUFFAGE PORTABLES ET/OU LES LAMPES DE COMBUSTION D'HUILE SONT EN FONCTIONNEMENT. LES APPAREILS DE CUISSON NE DOIVENT PAS SERVIR AU CHAUFFAGE DES LOCAUX.
	JA-110

### Ensure a supply of fresh air (Canada units only)

#### Calculating Propane Gas Usage

Most RV gas appliances are operated intermittently, and each has a different BTU rating. You will need to consider this when planning your propane supply and consumption. Unless there is heavy use of hot water, the water heater consumption of propane is minimal. During cool temperature or high wind conditions, furnace consumption can be extremely high.

To calculate your propane supply, take the BTU ratings for your propane appliances and divide that into the BTU availability. Each gallon of propane gas (3.785 liters) produces about 91,500 BTU's (96,528 kilojoules) of heat energy.

#### Propane consumption chart

The following chart provides average propane consumption information.

## SECTION 7: FUEL & PROPANE SYSTEM

Appliance	Average BTU Consumption per Hour	Kilojoules/Hour
Water Heater	8,800	9,280
Refrigerator	1,200 – 1,500	1,270 – 1,580
Furnace	35,000 – 40,000	36,930 – 42,200
Range/oven	7,100	7,490
Range, rear burner	6,500	6,860
Range, front burner	9,000	9,490
Outside Grill	10,000	10,550

**NOTE:** Some states prohibit propane appliances to be operated during travel, especially in underground tunnels. Make sure you know the laws for the areas where you travel.

### Traveling With Propane

Use care when fueling your motor fuel tanks and/or propane containers. Make certain your propane tank is properly fastened in place. This label should be kept permanently affixed to your recreation vehicle.

**⚠ DANGER**  
ALL PILOT LIGHTS, APPLIANCES AND THEIR IGNITORS (SEE OPERATING INSTRUCTIONS) SHALL BE TURNED OFF BEFORE REFUELING OF MOTOR FUEL TANKS AND/OR PROPANE CONTAINERS. FAILURE TO COMPLY COULD RESULT IN DEATH OR SERIOUS INJURY. W12 115

Refueling Warning Label

## INSTALLING PROPANE CYLINDER(S)

### ⚠ WARNING

Make sure all fasteners are secured before traveling.

### Single Cylinder Mounted On A-Frame (if so equipped)

1. Connect the 3/8" low pressure hose to the outlet of the two stage regulator.
2. Attach the regulator with the "Z" bracket on the center of the front wall with the vent pointing down.
3. Attach the protective plastic cover to the regulator.
4. The regulator has a 90° elbow that directs the inlet toward the trailer curbside.
5. Place the cylinder on the bracket provided on the A-frame and position it so the outlet of the cylinder valve is pointed directly outward to the curbside wall.
6. Attach the 1/4" inverted flare x 24" Type 1 pigtail hose to the regulator inlet and the right hand swivel nut to the cylinder valve.
7. Secure the cylinder to the A-frame bracket using the bolts, nuts and washers provided.

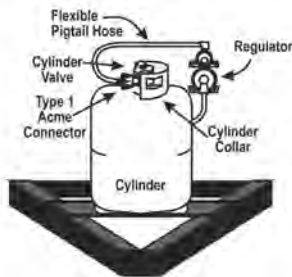

Single Cylinder

### Double Cylinder Mounted On A-Frame (if so equipped)

When a second cylinder is installed, a tee check valve is used to replace the 90° elbow at the top of the regulator and another 1/4" inverted flare x 24" Type 1 pigtail is added. The regulator stays in the original position.

Place the second cylinder on the A-frame bracket so the cylinder valve is pointed to the roadside of the recreation vehicle.

1. Secure the second cylinder to the A-frame using the bolts, nuts and washers provided.
2. Attach the second 24" hose to the tee check valve on the regulator and the right handed swivel nut to the cylinder valve.

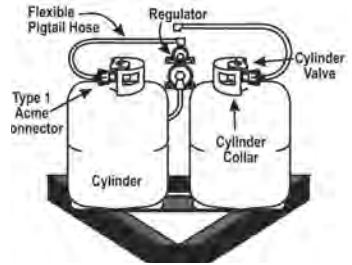

Double Cylinder

### Located in a recessed compartment or housing (if so equipped)

1. Connect the 3/8" low-pressure hose to the outlet of the two-stage regulator.
2. Place the cylinder on the bracket in the recess compartment or housing and secure them so the outlets of the cylinder valves are facing the "sidewalls" of the compartment or housing (opposite of each other).
3. Mount the regulator on the center back wall of the compartment or housing so the vent is pointed downward.
4. Attach the 1/4" inverted flare x 18" Type-1 pigtail hose to the regulator inlet and the right hand swivel nut to the cylinder valve.

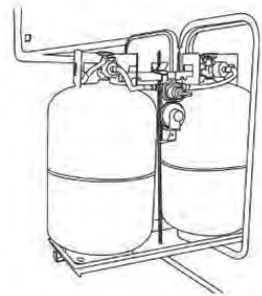

Two Propane Cylinders

### Main Supply Hose – Low Pressure

Attach the main supply hose from the regulator to the brass manifold fitting in the frame of the trailer. The swivel brass nut on the main hose will be your final attachment.

Each time the propane container is removed:

1. Check that ALL fittings are tight.
2. Check that ALL connections are tested with a propane leak detector (or soapy water) solution.
3. Open the main valve slowly to avoid a fast rush of propane to the excess flow valve causing propane freeze up. If you experience a propane "freeze-up," close the main valve and wait at least fifteen (15) minutes before trying again. Refer to the regulator manufacturer's operator manual.
4. Listen carefully - a "hissing" sound longer than one second may indicate a propane leak. If you feel there may be a leak present, close the valve and contact your dealer or qualified propane technician for repair assistance.

Replace all protective covers and caps on the propane system after filling. Make sure the valve is closed and the compartment door is securely latched.



Main Supply Hose

## **SECTION 7: FUEL & PROPANE SYSTEM**

**PLUMBING SYSTEM**

There are two different water systems in your recreation vehicle:

- The fresh water system consists of the fresh water holding tank, faucets and connections, water pump, outside shower assembly (if so equipped), water heater, tub/shower, and water purification system (if so equipped).
- The waste water system consists of the waste water and sewage holding tank(s), drains and toilet.

**Plumbing System Maintenance**

- Check all fittings, pressure and waste, for leaks before each trip or before vehicle storage as part of your normal maintenance.
- Inspect all faucets, the water purification system (optional) and sink connections (including drain baskets or filters).
- Inspect connections at the water pump and water heater.
- At the end of every trip, you should drain any unused water from the fresh water system.
- All water contains contaminant and mineral particles that can cause fresh water system odors. Untreated well water is a major source of water system odors.
- The fresh water (potable water) system needs periodic sanitization and winterization to take care of all the components within the plumbing system and help discourage the growth of bacteria and other organisms that can contaminate the water supply.

Typically, there are labels affixed to the exterior of the recreation vehicle sidewall that indicate the locations of the water system drains and fills. Be aware some drain valves may be located inside the vehicle (once the exterior label is found, go inside to find the drain corresponding location).

**MONITOR PANEL**

Monitor panel locations may vary by model. Typical locations are on the command center panel, on an interior wall, or on the exterior utility center.

It allows you to monitor the fresh water, grey water, black water and auxiliary battery levels. These functions are controlled using the tact switches. The monitor panel operates on 12-volt DC power supplied by either the converter or auxiliary battery. No power is drawn from the battery unless a switch is pushed or turned ON. Fuses for the monitor panel are located in the load center. Refer to the manufacturer’s operators manual for additional information.



**Monitor Panel**

**NOTE:** If your RV has secondary black or gray tanks, there may also be an additional tank monitor. located elsewhere in your RV. It is typically labeled as a convenience center.

**Operation**

Press only one tact switch at a time. As you push either the FRESH, BLK GREY1 or GREY2 switch, one or more LED lights will illuminate (from left to right) indicating the content level for that tank. When pushing the “BATT” switch, the LED lights illuminate from left (lowest) to right (highest) to indicate the estimated auxiliary battery condition.

## SECTION 8: PLUMBING SYSTEM

**NOTE:** When using shore power all 4 LEDs will light. If disconnected from shore power, 3 LEDs will light to indicate a full charge (4th LED may blink).

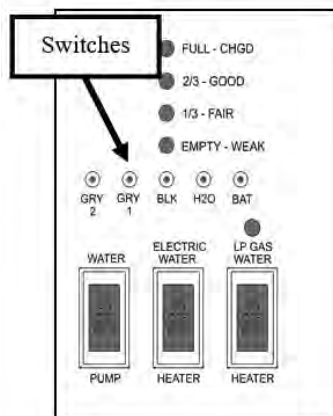

**Command Center**

**(monitor panel appearance and components may vary)**

The LEDs on the panel indicate the following:

- C = Charge at 12.7 volts
- G = Good at 12.1 volts
- F = Fair at 11.6 volts
- L = Low at 6.0 volts

**Water pump switch (if so equipped)** may be located on the monitor panel, the utility center or both. When the water pump switch is ON (it will light up), the water pump will run until it reaches 45 lbs. of pressure. It will recycle when pressure drops. Turn the switch OFF when the water pump is not being used.

**Water heater switch(s) (if so equipped)** are located on the monitor panel, and will light up when turned on. The "LP GAS" water heater switch (12V) enables propane operation of the water heater, and the "ELECTRIC" switch (120V) enables electric operation of the water heater. Normally both switches should be turned on to provide the fastest hot water recovery time. The water heater can be operated in electric only or gas only modes by pressing each switch independently. If the RV is equipped with a tankless water heater, there will be only an LP Gas switch on the command center panel.

**DSI FLT - Direct Spark Ignition Fault (if so equipped):** This light located between the water heater switches will indicate a problem with the LP portion of the water heater. When the LP GAS switch is turned on, the light will blink quickly 3 times and the water heater will ignite. The light will then remain off. If the light comes on and stays on, it indicates the gas side of the water heater has not fired and there is a problem with the igniter.

### **FRESH WATER SYSTEM**

All water contains contaminant and mineral particles that can cause fresh water system odors. Untreated well water is a major source of water system odors. The fresh water (potable water) system needs periodic sanitization and winterization to take care of all the components in the plumbing system to discourage the growth of bacteria and other organisms that can contaminate the water supply.

## **⚠ WARNING**

- DO NOT drink water deemed microbiologically unsafe or of unknown quality.
- Never travel with full fresh, black or grey water holding tanks.

### Water Pressure Regulator (customer supplied)

Excessive pressure from the water supply source may be encountered in some parks, espe-

## CAUTION

A water pressure regulator is recommended to prevent damage to the plumbing system or components. To prevent damage when using the city water connection, a 45 lb. (315 KPa) rated water pressure regulator is recommended.

cially in mountain regions when using the fresh water inlet or black tank flush. Water pressure regulators are available to protect your recreational vehicles plumbing system against such high pressure.

### Fresh Water Holding Tank

There may be several ways to fill the fresh water tank depending on the model. For details of each method, refer to the *Fresh Water Connections* or the *Utility Center (if so equipped)* sections. There are plastic overflow tubes in the fresh water holding tank which allow water to flow out of the water tank (see *City Water Fill*). Occasionally, you may see water coming from the overflow tubes when the fresh water holding tank is filled. This is normal and can be a result of the recreation vehicle being parked on an incline, or the motion caused by starting or stopping during travel.

## CAUTION

- Do not cap, block or modify the fresh water tank overflow tubes in any way. Enough water pressure can build up during the filling process to damage the plumbing system if the overflow tubes are obstructed.
- Be careful not to overfill the fresh water holding tank. It can pressurize the tank, causing leakage and water damage and void the warranty. DO NOT leave the tank unattended while filling.

### 12-Volt Water Pump and Switch

When you want to use water in your recreation vehicle and it is not hooked up to city water, you will need sufficient 12-volt DC power to run the water pump.

Once activated, the water pump (also known as the demand pump) will self-prime, and provide water. The pump is designed for **intermittent use only**. Using the pump continuously or with high pressure will shorten the life of the pump and is not covered in your warranty. Periodically check the in-line water pump strainer for accumulated debris. To clean, shut off the water pump, unscrew the clear cap, remove the re-useable metal strainer and clear any debris, then reinstall.

For additional information on the care and operation of the pump, read the safety and operating information in the pump manufacturer's owner's manual.

### Water Pump Switch (if so equipped)

Most water pump switches illuminate when the water pump is activated. In most models, the (red) pump switch is located on the monitor panel or the utility center. When the water pump switch is ON the pump runs until 45 lbs. of pressure has been achieved. The red light will stay on. The water pump automatically recycles when pressure drops. Some cycling may occur depending on the volume of water being released. Turn the water pump switch OFF when it is not in use.

## SECTION 8: PLUMBING SYSTEM



**NOTE:** In some models the water pump switch will be a black rocker switch located near the sink cabinet

Water pump strainer



The water pump switch should be in the OFF position when the RV is left unattended for any amount of time. If something would happen to the water system, this may help limit water damage to a smaller area.

### **DRAINING THE FRESH WATER SYSTEM**

Water tanks may be drained through a valve located near the tank. A recreational vehicle with a demand pressure pump system will have low-point drains attached to the water lines (normally located near the water tank).

These low-point drains will release water in the supply lines by opening the valves and all faucets. The water heater has its own drain plug. To drain the permanent fresh water holding tank and supply lines:

1. Turn the water heater power OFF (turn off the electric & LP GAS switches).
2. Open all faucets, including the outside shower faucet (if so equipped).
3. Open the “fresh tank drain” valve. All fresh water tanks can be drained by one of two types of drain valves. A white plastic drain is attached to the exterior wall or a valve located inside the RV adjacent to the water tank (turn 45° to open or close).
4. Open the “low point drains” by turning, then pulling the handles up. They are installed at the lowest point of the water lines. A label is placed on the outside of the RV to indicate where the drains are located. The drains will need to be operated from inside the RV. Once the label is found on the exterior sidewall, the drains will be found at a corresponding location in the interior.
5. Drain the sink by removing the drain cap.
6. Turn ON the water pump and allow it to run as needed.
7. If the RV water heater has bypass valves: Set them to the BYPASS configuration (refer to the *Water Heater Bypass* section).
8. Operate the toilet flush lever until water stops flowing.
9. Relieve the water pressure using the P&T valve BEFORE removing the water heater drain plug. If there is any water pressure present, the water will spray out of the opening when the drain plug is removed.



Exterior Fresh Water Drain



Low Point Drains

When you are finished draining the fresh water system, reverse these steps and dump the grey and black water holding tanks. It is normal for some liquid to remain in the fresh water tank after drainage procedure.



**UTILITY CENTER – 2 VALVES (6 IN 1)**

Your RV may be equipped with a small lockable enclosed docking station, which provides convenient access to certain plumbing system functions at one central location.

The 6 in 1 utility center contains the following features:

1. City water / tank fill valve
2. Lighted white switch (switch itself acts as a light for the panel)
3. Pump switch (lights red when ON)
4. Fresh water connection inlet
5. Outside shower hookup (with quick connect for the shower hose)
6. Black tank flush inlet
7. Hookups for satellite TV (up to 3 total connections)
  - SAT1 input is wired only to the wall plate for the satellite receiver (can be used with a tripod mounted satellite antenna also).
  - SAT2 input is wired only to the wall faceplate at the main TV. This connection would not be used for OTA (over-the-air) signals for local TV stations. There is an HDTV antenna on the roof for local stations and it is wired separately to the faceplate at the main TV.
  - SAT3 input is wired to wall faceplates of any other secondary TVs in the RV (i.e. bedroom or exterior). This AUX input is designed for use with an outdoor portable satellite dish system mounted on a tripod.

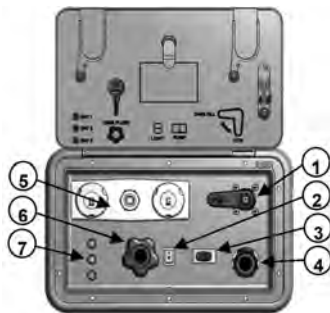

## ⚠ CAUTION

**Never** leave the recreation vehicle unattended while filling the fresh water system. Water running continuously while the RV is unattended can result in major water damage to RV which will not be covered under your warranty. **WATCH YOUR MONITOR PANEL – LEDs will indicate your water tank level as it fills.**

**NOTE:** The country fill and sanitizing/winterizing functions are performed from a pair of (2) two way valves plumbed inside the RV; a black valve on the suction line, and a white valve that directs water to the fixtures or the water tank.

Pump and water heater bypass locations will vary according to the model. Locate the pump by turning it on briefly and listening for it to run. Locate the water heater vent on outside of the RV and the water heater bypass valves will be in the same location. They are typically located inside the RV behind a panel or inside a cabinet.

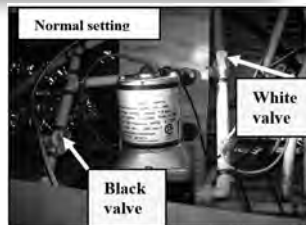

## SECTION 8: PLUMBING SYSTEM

### Fresh Water Connection Inlet

The fresh water connection should be unplugged (i.e., the non-toxic drinking water hose disconnected) when the recreation vehicle is unattended for any amount of time. If something would happen to the water system, this may help limit water damage to a smaller area.

**NOTE:** If needed sanitize the water system prior to travel.

1. Water heater bypass valves should be set to **NORMAL** (refer to the *2-Valve Water Heater Bypass* section). Make sure the water heater drain plug is in place on the water heater. Bypass valve handles should point toward the water heater.
2. Set the blue **CITY WATER / TANK FILL** valve (on utility center) to the **CITY WATER** (vertical) position (pointing down).
3. Make sure both water valves at the water pump are in the **NORMAL** positions (see water valve configurations).
4. Attach a fresh water hose to the fresh water connection inlet on the panel. Attach the other end of the hose to a pressurized fresh water source.
5. Turn on the pressurized water to supply fresh water at all fixtures inside the recreation vehicle. The 12V pump is not used for this feature.
6. Open the cold water supply faucets to bleed air from the water lines. When the water lines are nearly full, you may experience some "air pockets". Allow these to escape before closing the cold water supply faucets.
7. The water heater will fill first, followed by the supply lines and faucets. Open the hot water faucets until air is bled off and the water is a steady stream. Close faucet.
8. Turn the appropriate (12-volt gas or 120-volt electric) water heater control switch ON. The water heater must be full of water before turning it ON.
9. To verify water heater is full, open hot water faucets, turn pump ON, and when water comes out in a steady stream the water heater should be full. Shut off faucets and the pump.

**To disconnect**, shut OFF the water at the external water source. Disconnect the hose from the water source first, then disconnect from the utility center panel.

### Water Valve Configurations

**NORMAL (CITY WATER):** This setting will supply fresh water to all fixtures in the RV from a pressurized water source attached to the utility center panel.

1. Utility center valve should be set to **CITY WATER** position (pointing down).
2. White valve should be pointing toward the pump as shown.
3. Black valve should be pointing toward the pump strainer as shown.

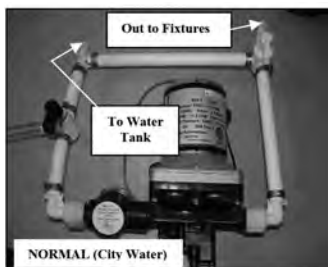

The pump is **not** used to supply water to fixtures when a pressurized water source is attached to the utility center city water inlet.

**PRESSURE FILL WATER TANK:** This setting will fill the water tank from a pressurized water source attached to the utility center panel.

1. Set the blue CITY WATER / TANK FILL valve at the utility center to the **TANK FILL** position (horizontal) pointing to the left (as shown).
2. Water valves at the water pump should be in the **FILL TANK** positions.
3. Black valve pointing to the pump strainer, white valve pointing to the left (toward the water tank).
4. Attach a fresh water hose to the fresh water connection inlet on the panel. The other end of the hose should be attached to a pressurized fresh water source.
5. Turn on the pressurized water to fill the fresh water tank. The 12V pump is **not** used for this feature (water tank drain valve must be closed).
6. When the water tank is full, turn off the water source and disconnect the hose from the water source, the disconnect from the panel. Set the blue lever to the **CITY WATER** position.
7. Return the valves at the water pump to the **NORMAL** positions.



### SANITIZE/WINTERIZE LINES

This setting will allow sanitizer or antifreeze into the water lines (but not the water tank).



**NOTE:** Utility center blue valve position does not matter as it is not used for sanitizing or winterizing.



- White valve should be pointing toward the pump as shown.
  - Black valve should be pointing toward the clear suction hose.
  - Place the clear hose into a container of sanitizer solution (or antifreeze if winterizing).
- Turn the pump ON, and sanitizer or antifreeze will be drawn out of the container and into the water lines. Refer to *Sanitizing the Plumbing System* or *Winterizing the Plumbing System*. Refer to the (2) *Valve Water Heater Bypass* section as **antifreeze should always be kept out of the water heater**.

**SANITIZE TANK:** This setting is for putting sanitizer into the fresh water tank (refer to sanitize tank and country fill diagram).



**NOTE:** Utility center blue valve position does not matter as it is not used for sanitizing.

- Black valve should be turned so it points to the clear suction hose.
- White valve should be pointing left toward the water tank as shown.

## SECTION 8: PLUMBING SYSTEM

- Place the clear suction hose into a container of sanitizer solution. Turn the pump switch ON and sanitizer will be drawn into fresh water tank.



**NOTE:** Make sure you have sufficient 12V power and all drain valves are closed to create a siphon.



**COUNTRY FILL:** This setting allows you to fill the fresh water tank from a container of water in the absence of a pressurized water source.



**NOTE:** Utility center blue valve position does not matter as it is not used for sanitizing.

- Black valve should be pointing to the clear suction hose.
- White valve should be pointing left toward the water tank.

This setting is identical to the **SANITIZE TANK** setting. Instead of placing the clear hose in a container of sanitizer, place it in a container of fresh water. Turn water pump ON and water will be siphoned out of the container and into the fresh water tank. **All drain valves must be closed to create a siphon.**

**Do not remove the potable water label from your recreation vehicle.**

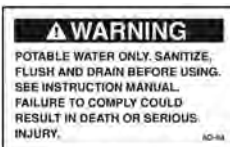

Potable Water Label

### Water Heater Bypass (2 Valves):

Most floor plans have a factory installed water heater bypass that enables you to avoid filling the water heater with RV antifreeze. Bypass valves are typically located in close proximity to the water heater. Outside utility centers (if so equipped) operate differently than a factory installed bypass system. Refer to the *Outside Utility Center* section for details.

### Operation:

**Normal Mode** operation allows water to flow into the water heater. Hot water bypass valve handle (B) should point toward the water heater. Cold water bypass valve (A) should point toward

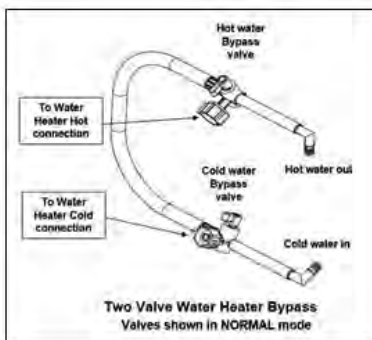

the water heater.

**Bypass Mode** operation diverts the flow of water around the water heater keeping water out of the water heater. Hot water bypass valve (B) should point away from water heater and inline with the hot water output. Cold water bypass valve (A) should point away from the water heater and inline with the cold water supply.

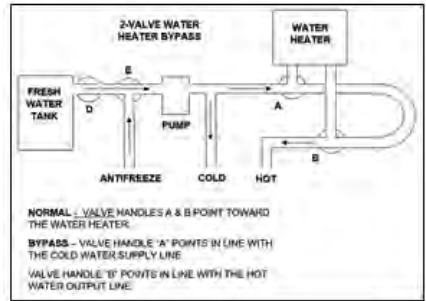

**NOTE:** Valve E is the suction (syphon) valve that has the clear hose attached to it for siphoning in antifreeze, sanitizer or fresh water from an external container. Valve D (if equipped) is a shutoff valve for the fresh water tank. Both valves are typically located at the water pump

### Sanitizing the Plumbing System

#### **When to sanitize:**

- When your RV is new.
- At the beginning and end of each season.
- When the water system becomes contaminated or every three months of use.

#### **How to sanitize**

1. Turn both the electric and LP gas water heater switch(s) to OFF. Set the 2-valve water heater bypass to **BYPASS**. Refer to the *2-Valve Water Heater Bypass* section.
2. Level the RV and drain the fresh water system. See *Draining the Fresh Water System*.
3. Close the low point drain valves and the fresh water tank drain valve. Low point drains for hot and cold water lines are located inside the basement access cover.
4. **Full system canister water filter (if so equipped):** Remove the canister; take the filter out of the canister, then reattach the empty canister. There may be water valves at the canister to turn water off coming in to and leaving the canister filter.
5. Prepare a chlorine solution using 1/4 cup of household bleach (sodium hypochlorite solution) to one gallon (3.785 liters) of water in a container. Prepare one gallon of solution for every 15 gallons of tank capacity. This will result in a residual chlorine concentration of 50 ppm in the water system.

If a 100-ppm concentration is required, use 1/2 cup of household bleach with one gallon of water to prepare the chlorine solution. One gallon of the solution should be used for each 15 gallons of tank capacity.

**NOTE:** Fresh water tank sizes vary by model; contact your dealer or Customer Service for your specific tank size.

## SECTION 8: PLUMBING SYSTEM

6. Put the sanitizer solution in the fresh water tank. Place the end of the clear plastic tubing (found inside the basement access panel or at the water pump) into a container of chlorine solution.
7. Turn the black valve (at the pump) so it is pointing to the clear siphon hose. Turn the white valve (at the pump) so it is pointing to the left toward the water tank line (as shown in **Sanitize Tank & Country Fill** photo above).
8. Turn the water pump ON, and sanitizing solution is siphoned into the fresh water tank. Tank drain valve must be closed to create a siphon.
9. Once the sanitizer is in the tank, finish filling it with fresh water. The tank may be filled in one of two ways. It can be pressure filled using an external pressurized water source, or it can be siphon filled using the clear plastic hose and a container of fresh water. (The valves in the following two examples are located at the water pump)  
**To Siphon Fill:** Set the BLACK valve so it points to the clear hose. White valve points left to the water tank. Put the clear hose in a container of fresh water and turn on the pump. Check tank level by watching monitor panel LEDs inside the RV.  
**To Pressure Fill:** Turn the BLACK valve so it points to the pump strainer. Turn the WHITE valve so it points left toward the water tank. Attach a pressurized water source to the city water inlet on the utility center panel. Turn the blue CITY WATER/TANK FILL lever on the utility center panel to the **FILL TANK** position (horizontal). Turn on the water source and the tank will fill. Refer to the **Pressure Fill Tank** photo above. Turn OFF the water source and remove the hose from the water source, then remove the hose from the utility panel. Check the tank level by watching monitor panel LEDs inside the RV.
10. When the tank is full, the two valves at the water pump must be set to the **NORMAL** position. Turn OFF water heater power (both gas and electric switches). Turn the pump ON and sanitized water from the water tank will circulate through the water lines in the RV (when a fixture is opened). The water heater valves should be set to **BYPASS** mode.
11. Open all hot water faucets one by one until water begins to flow continuously and a chlorine smell is noticeable. Include outside shower faucets (if so equipped). Also include outside kitchen faucet also if equipped.
12. Close the hot water faucets and repeat opening all cold water faucets one by one until you smell chlorine. Include outside shower faucets (if so equipped). Also include outside kitchen faucet also if equipped.
13. Turn the water pump OFF.
14. Let the solution remain in the tank and lines for at least four hours when disinfecting with 50-PPM residual chlorine. If a shorter time period is desired, then a 100-PPM chlorine concentration should be permitted to sit in the system for at least one hour.



**NOTE:** To thoroughly sanitize the fresh water tank, the unit should be driven around for a short while allowing the solution to splash the sides and top of the tank.

15. After sanitizing, drain the chlorine solution from the fresh water system. See *Draining the Fresh Water System*.

16. Pressure fill the fresh water tank (refer to Step 9). Set the 2 valve water heater bypass to **NORMAL** allowing water into the water heater. Refer to the *2-Valve Water Heater Bypass* section.
17. Water valves at the water pump should be in the **NORMAL** position to allow water into the RV lines. Disconnect any pressurized water source. Turn the water pump ON. You want water to flow from the water tank into the water lines in the RV.
18. Verify the hot water heater is full of water by turning on the hot water faucets and when a steady stream of water flows from the hot faucets, pump must be ON, then the water heater is full of water.
19. Open all faucets one by one (both hot and cold) and allow water to flow until the chlorine smell is gone. Include the outside shower and outside kitchen also.
20. Close the faucets and then turn the pump OFF.

**Lingering Chlorine Taste:** If a chlorine taste lingers in the water, flush the water system with a solution consisting of one-quart vinegar to five gallons of clean water. Re-flush as necessary. **The vinegar solution may damage the water heater and water filter. Both must be bypassed prior to adding the vinegar solution.**

Follow the steps outlined in *Draining the Fresh Water System* with one exception, do not drain the water heater. Set the **water heater bypass** valves to **BYPASS** mode. **Do not** remove the water heater drain plug.

**Full System Canister** water filter (if so equipped), remove the canister, take out the filter, and reattach the empty canister.

### **After draining the system**

1. Water heater power should be OFF (both switches: electric and LP gas). Set the water heater bypass valves to **BYPASS** mode.
2. Siphon the vinegar solution into the fresh water tank. Place the clear tubing (located inside the basement access cover at the pump) into a container with the vinegar solution. Tank drain valve must be closed to create a siphon.
3. Set the black and white valves at the water pump to the **SANITIZE TANK** setting (refer to the *6 In 1 Utility Center – 2 Valve System* section). Turn the water pump ON and vinegar solution will be drawn into the fresh water tank.
4. Finish filling the fresh water tank with of clean (potable) water. Turn the pump OFF. Fill the fresh water tank using one of the methods in Step 9 previously. Refer to the *6 In 1 Utility Center – 2 Valve System* section.
5. Set the **BLACK** and **WHITE** valves at the water pump to the **NORMAL** positions. Turn the pump ON. Run water through all faucets (hot and cold, including outside shower) until chlorine smell is gone.
6. Close all faucets including outside shower. Turn pump OFF.
7. Drain the system again, but do not drain the water heater. Water heater bypass valves should be set to **BYPASS** mode. Do not remove water heater drain plug.
8. Close low point drains and fresh water tank drain. Low point drains for hot and cold water lines are located inside the basement access cover.
9. Refill the fresh water tank with clean potable water. Use either the **pressure fill tank** method or the **siphon fill tank** method. Refer to the *6 In 1 Utility Center – 2 Valve System* section.
10. Reset the black and white valves at the water pump to the **NORMAL** position. Turn the pump ON. Open faucets and check that the chlorine taste is gone.
11. Turn water pump OFF. Drain the system one more time. See *Draining the Fresh Water System*.

## SECTION 8: PLUMBING SYSTEM

12. Remove full system canister, insert the filter, and re-attach canister to the mount. For **2-Valve Bypass (if so equipped)**, set the water heater bypass valves to the **NORMAL** position.
13. Refill the fresh water system with clean water. Use pressure fill or siphon fill method explained previously. Turn the water heater power ON only when the water heater is full of water.
14. To verify water heater is full, open hot water faucets, turn pump ON, and when water runs in a steady stream from the faucets, the water heater is full. Turn OFF the pump and the faucets.



**NOTE:** If filling the fresh water tank remember to set the two valves at the water pump back to the NORMAL position when the tank is full.

### Winterizing (with Utility Center)

Preparing your recreation vehicle for colder weather or storage is very important for most states and Canada. Failure to prepare your RV may cause water supply lines and the water heater to freeze. The RV should be winterized at the end of the camping season or when it will be exposed to temperatures that will fall at or below 32°F (0°C). Repairs due to freezing are not covered by warranty.



**NOTE:** The winterization process may vary slightly due to different plumbing configurations between models.



**NOTE:** Appliances (refrigerator, dishwasher or clothes washer) must be winterized. Refer to the appliance owner's manual for possible additional information or contact your Dealer or Customer Service for assistance.

If you choose to perform the winterization process yourself, read and understand the following information before starting. Contact customer service or your dealer for questions about this process. It may be easier to winterize the RV with another person to assist you.



**NOTE:** The water heater must be drained to prevent damage from freezing. It is recommended the water heater be drained and bypassed during the winterization process particularly if introducing RV antifreeze into the plumbing system. **Do not drain the water heater while it is hot or under pressure!** Antifreeze should be kept out of the water heater.



The preferred method to winterize your recreation vehicle is by using RV antifreeze in the plumbing system.

### Air Pressure Method

## **⚠ CAUTION**

If the recreation vehicle is going to be stored in a non-temperature controlled environment with a risk of temperatures reaching 32°F (0°C) or lower, the air pressure method is not adequate, winterizing with RV antifreeze **must** be used in the plumbing system. Repairs due to freezing are not covered under the terms of the **Towable Limited Warranty**.

This method utilizes a blowout plug, an air compressor and an air hose to remove excess water out of the water lines.

## **⚠ WARNING**

- Never apply air pressure to the water system with any of the valves in the closed position. Air pressure applied to a closed valve, faucet or low point drain could potentially damage the seals and cause water leaks. If you have questions, consult with your RV dealer. Using RV antifreeze is the preferred method of winterization.
- **Recommended pressure is 30 PSI, exceeding this pressure may rupture water line couplings and void your warranty.**

1. Water heater power should be OFF (turn off both ELECTRIC and GAS switches).
2. Water heater bypass should be in **NORMAL** position. Refer to the *2-Valve Water Heater Bypass* section.
3. The two water valves located in the basement compartment or next to the water pump should be set to **NORMAL**; black valve should be pointing away from the clear plastic hose. White valve should be pointing toward the pump. Refer to the *6 in 1 Utility Center – 2 Valve System* section.
4. Level the RV and drain the fresh water tank, water heater and hot and cold water lines. Open all low point drains and fresh water tank drain. Faucets inside the RV need to be opened also to relieve pressure and allow lines to drain. Refer to *Draining the Fresh Water System* section.
5. Remove the drain plug from the water heater (as shown).
6. RV water filter should be removed for winterizing. Refer to *Water Purification System* section. Your RV may have one of two types of filters:



**Water heater drain plug**

**Full System Canister Filter (if so equipped):** On full system canister water filters, remove the canister, take out the filter, and reattach the empty canister.

**Cartridge Water Filter:** Remove the cartridge filter, and replace it with a bypass tube typically supplied with your RV.

## SECTION 8: PLUMBING SYSTEM



**NOTE:** Filters should be replaced at the beginning of the camping season or if they have come into contact with contaminated water or antifreeze.

7. Run the water pump until it is dry (approximately 15 to 20 seconds). Operating the pump longer than that with no water in it can damage the pump.
8. Open all faucets in the RV. If there is an outside shower, attach the shower hose to the shower, and open the shower faucets (also outside kitchen if equipped).
9. Attach a blowout plug to the city water inlet on the utility center panel.
10. Attach the air hose to the blowout plug. Set compressor to **30 PSI MAX**. Set the blue CITY WATER / TANK FILL valve on the utility center panel to **CITY WATER**.
11. Open the fresh water tank drain. At the pump, turn the white valve so it points to the left (to the water tank). Blow air into the blowout plug, which will clear the water tank. Apply air for only 30 to 60 seconds. Then turn the white valve so it points toward the pump.
12. Continue blowing air into the water lines to evacuate all water from the lines. This can take 5 to 10 minutes.
13. Appliances should be winterized to prevent damage. Refrigerator, dishwasher, clothes washer should be winterized. Refer to the appliance owner's manual for instructions or call Customer Service.
14. Pour one cup of RV antifreeze in all the drain P-traps (sinks and bathtub).
15. After RV water lines and appliance water lines have been blown out, remove the air hose and the blowout plug from the utility center.



**Blowout plug**

### **Winterize the Black Tank Flush**

1. Connect the blowout plug to the black tank flush inlet at the utility center panel.
2. Connect the air hose to the blowout plug. Set the compressor to **30 PSI maximum**.
3. **Make sure the black tank has been emptied.** Open the black tank drain valve.
4. Blow air into the flush inlet for 30 to 60 seconds.
5. Disconnect the compressor and blowout plug.
6. Close the black tank drain.

### **Winterizing with Antifreeze Method**

Requires non-toxic RV antifreeze in the water lines and does not require any special tools. Use **ONLY RV ANTIFREEZE** in your fresh water system for freeze protection. No other product or commodity should be used.

## **⚠ WARNING**

Automotive antifreeze (ethylene glycol) and windshield washer antifreeze (methanol) are poisonous. Never use these products in your fresh water system. These products are harmful and may be fatal if swallowed.



**NOTE:** Antifreeze should **never** enter the hot water heater or the water filter.

1. Turn power to the water heater OFF (both electric and LP gas switches).
2. Level the recreation vehicle and drain the fresh water plumbing system. See *Draining the Fresh Water System*.
3. Replace the water filter cartridge (if so equipped) with the plastic bypass hose. If RV has a canister water filter, turn off water to the filter (valves should be on either side of the filter). Remove the lid, remove the filter, replace the lid. Turn on the water valves.
4. Water heater should now be empty after performing Step 2. The water heater bypass valves should be set to **BYPASS**. Refer to *2-Valve Water Heater Bypass* section.
5. Make sure the “fresh water tank drain” and “low point drains” are all closed. Low point drains are typically located inside the basement access cover for hot and cold water lines.
6. Open the basement access cover to locate the **BLACK** and **WHITE** water valves and set them to **SANITIZE/WINTERIZE** positions (as shown).
7. Place the end of the clear plastic hose into a container of RV antifreeze.
8. Turn the water pump switch ON. Antifreeze will siphon into the water lines when a fixture is opened. To aid in siphoning, place the container of antifreeze on a flat surface 2 feet above the ground. All drains should be closed to create a siphon.
9. Open each hot water faucet one at a time, including outside shower and outside kitchen (if so equipped) until RV antifreeze begins to flow continuously then close the water faucet. Repeat for all hot water faucets.
10. Repeat Step 8 with the cold water faucets including outside shower and outside kitchen (if equipped).
11. Hold open the lever on the toilet until antifreeze runs into the bowl.
12. Appliances should be winterized to prevent damage. Refrigerator, dishwasher, clothes washer should be winterized. Refer to the appliance owner’s manual for instructions or call Customer Service.

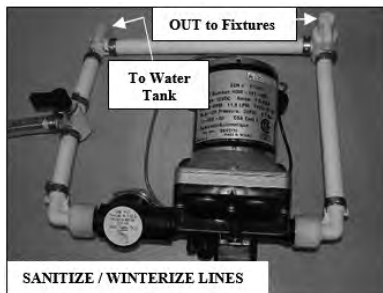

### **Winterizing the Macerator System (if so equipped)**

1. Ensure all tanks are empty.
2. Pour RV antifreeze into the empty black water tank (through the toilet bowl). (Be sure to have a container available for capturing system fluid.)
3. Turn the macerator pump ON.
4. Run the pump until antifreeze begins to discharge from the dump connector on the end of the flexible hose.
5. Turn the macerator pump OFF.

## SECTION 8: PLUMBING SYSTEM

6. Drain the hose by holding it at a sloped angle to remove excess water, return hose to the stored location.
7. As an added safety measure, drain the macerator bypass valve.

**De-winterize the macerator system:** Emptying the black tanks in the spring will flush antifreeze out of the macerator system.

### **When you are finished adding RV antifreeze**

1. Turn the water pump OFF. Remove the plastic hose from the container. Leave the black valve pointing to the clear hose.
2. Pour 1 cup of RV antifreeze into all sink drain P-traps.
3. To prevent staining, wipe the RV antifreeze out of the sinks, shower (or tub) and toilet using a soft, dry cloth.



**NOTE:** In the spring when flushing antifreeze out of the water lines make sure to set the (2) valves at the pump to the NORMAL position.

This will allow water to be drawn out of the fresh water tank using the pump (after the tank is full) and into the water lines.

Refer to the *6 in 1 Utility Center – 2 Valve System* section. Make sure the low point drains are open to flush antifreeze from the lines.

## **NAUTILUS P2.5 UNI-DOCK UTILITY CENTER**

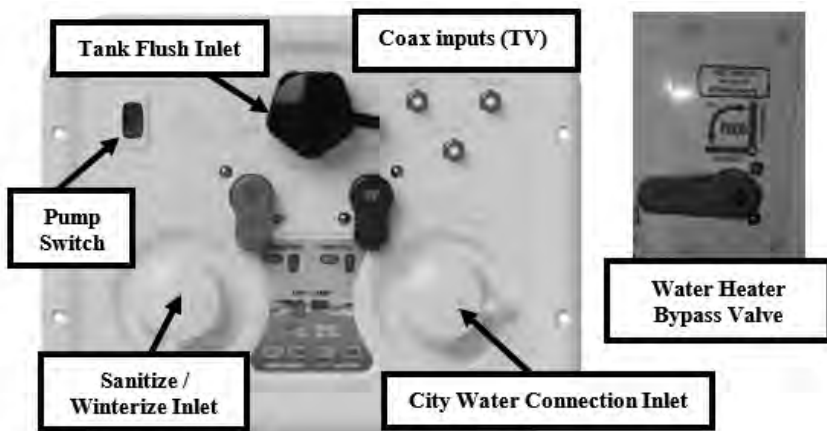

**The Uni-Doc Utility Center** is located in an exterior compartment and allows you to perform the following functions:

- Power fill the fresh water tank for remote or dry camping
- Use the pump to supply water to fixtures from the fresh water tank
- Use the pump to siphon fill or sanitize the fresh water tank from a bucket
- Connect to city water at the camp site to supply water to RV fixtures
- Winterize the plumbing lines and fixtures
- Bypass the hot water heater when winterizing to avoid damage to the water heater

## SECTION 8: PLUMBING SYSTEM

- Rinse the black tank to help control odors and prevent waste buildup
- Connect up to (3) coax lines with SAT, CABLE and AUX
  - SAT input is wired only to the wall plate for the satellite receiver.
  - CABLE input is wired only to the wall faceplate at the main TV. The faceplate can switch between CABLE & the outside HDTV antenna. (Refer to *Section 11 Antenna System*).
  - AUX input is wired to wall faceplates of any other secondary TVs in the RV (i.e. bedroom or exterior). This AUX input is designed for use with an outdoor portable satellite dish system mounted on a tripod.

Located above the utility center main panel will be a separate red handled valve to operate the Water Heater Bypass. The valve has 2 positions NORMAL and BYPASS.

The city water connection inlet is located in the Uni-Dock utility center. Use a non-toxic drinking water hose dedicated only to supplying fresh water. To prevent contamination, keep the non-toxic drinking water hose from coming into contact with the ground. Install the city water connection inlet cap when the fresh water connection is not being used.

The fresh water connection should be disconnected (i.e., the non-toxic drinking hose disconnected) when the recreation vehicle is unattended for any amount of time. If something would happen to the water system, this may help limit water damage to a smaller area.

**Do not remove the potable water label.**

**Nautilus - 2 Valve Position and Routing Information:**

**Green Handle:** Receives water from Sanitize/Winterize inlet on front panel.

Sideways: Water goes from the inlet to the pump.

Downward: Water goes to the fresh water tank.

**Blue Handle:** Receives water from the City Water Connection inlet on front panel.

Sideways: Water goes to fixtures in the RV (cold).

Downward: Water goes to or from the fresh water tank.

**Using the Uni-Doc utility center:**

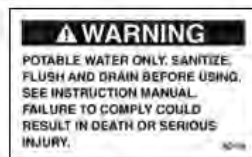

**Potable Water Label**  
(Label appearance may not be exact)

### ⚠ WARNING

A check valve is located inside the city water connection inlet on the utility center. NEVER depress the check valve on the "CITY WATER CONNECTION" inlet with pressure in the line. It will cause irreparable damage to the valve function and the inlet will leak water.



The following information details the functions of the utility center water valves as displayed on the valve operation label.



## SECTION 8: PLUMBING SYSTEM

### “POWER FILL TANK” (Pressurized fresh water source)

1. Connect the fresh water hose to the City water connection inlet on the utility center.
2. Set the color coded valves to POWER FILL TANK setting:
  - Green handle pointing left
  - Blue handle pointing down
  - Water heater bypass lever - NORMAL
3. Connect the other end of the hose to a pressurized fresh water source (faucet or spigot).
4. Turn the pressurized water source ON, the tank should begin filling.
5. When water has reached the desired level, turn the pressurized water source OFF. **DO NOT OVERFILL** (tank level can be viewed on the monitor panel inside the RV).
6. Disconnect water source from the spigot/faucet first, then disconnect from the city water fill inlet on the utility center.



### “DRY CAMPING” (pump supplies water from the fresh water tank)

1. Make sure the fresh water tank has an adequate supply of water.
2. Set the color coded valves to the DRY CAMPING setting:
  - Green handle pointing down
  - Blue handle pointing right
  - Water heater bypass lever - NORMAL
3. Turn the pump switch ON.
4. Water should be available to all fixtures. Pump runs when a fixture is opened.
5. Turn pump OFF when water is not being used.



**NOTE:** To fill the fresh water tank without a pressurized water source, refer to SANITIZE (Siphon Fill) section, and use a container holding fresh potable water and your fresh water hose. Water will be drawn into the tank by the pump. There is no gravity fill inlet on the recreation vehicle.

### “CITY WATER” (Pressurized fresh water source)

1. Connect the fresh water hose to the city water inlet.
2. Set the color coded valves to the CITY WATER setting:
  - Green handle pointing left
  - Blue handle pointing right
  - Water heater bypass lever - NORMAL
3. Connect other end of the hose to the pressurized fresh water source.
4. Turn ON the pressurized water source.
5. Water should now be available to all fixtures in the RV.



**To disconnect:** Turn off water at the pressurized source first, disconnect hose from the water source, (to release pressure off the system) then disconnect the hose at the city water connection on utility center last.

### “SANITIZE” (or Siphon Fill) the Fresh Water Tank via Pump



**NOTE:** Refer to the *Sanitizing Plumbing System* section for complete instructions on how to sanitize the water lines.

### “WINTERIZE” (plumbing lines and fixtures via pump)



**NOTE:** Refer to the *Winterizing Plumbing System* section for complete instructions on how to winterize the water lines and fixtures.

### Sanitizing The Plumbing System: (with a tank (storage) water heater)

#### When to sanitize:

- When your RV is new.
- At the beginning and end of each season.
- When the water system becomes contaminated or every three months of use.

#### How to Sanitize

1. Turn water heater power OFF (both electric and LP gas on standard storage water heater). Set the colored valves to **SANITIZE/WINTERIZE** setting:
  - Green valve pointing left.
  - Blue valve pointing down.
  - Set the red water heater bypass lever to **BYPASS**. Red lever will be pointing up.



**NOTE:** Refer to the valve operation diagram on the utility center for positions of the colored valves. The water heater bypass valve is located in the utility center bay.



2. Level the recreation vehicle and drain the fresh water system (see **Water Heater Bypass** *Draining the Fresh Water System*). Do not drain the water heater or remove the water heater drain plug.
3. Close the low point drain valves and the fresh water tank drain valve.
4. Remove and bypass the water filter:

#### **Full System Canister water filter** (if so equipped):

Turn water valves off at the canister. Remove the canister lid, take the filter out of the canister, then replace the lid and turn the water valves back on.

#### **Bypass the cartridge water filter** (if equipped):

Use the clear plastic tube (supplied with RV) to bypass the water filter.

## SECTION 8: PLUMBING SYSTEM

5. Prepare a chlorine solution using 1/4 cup of household bleach (sodium hypochlorite solution) to one gallon (3.785 liters) of water in a container. Prepare one gallon of solution for every 15 gallons of tank capacity. This will result in a residual chlorine concentration of 50 ppm in the water system.

If a 100-ppm concentration is required, use 1/2 cup of household bleach with one gallon of water to prepare the chlorine solution. One gallon of the solution should be used for each 15 gallons of tank capacity.



**NOTE:** Fresh water tank sizes vary by model. Contact your dealer or Customer Service for your specific tank size.

6. Attach a short section of garden hose to the SANITIZE/WINTERIZE inlet at the utility center. **DO NOT use your fresh water hose for sanitizing.**
7. Insert the other end of the short hose into a container holding the chlorine solution from step 5.
8. Turn the pump switch ON (red LED will light). The solution will be drawn into the fresh water tank. Turn the pump OFF when solution has been drawn into the tank. To aid in siphoning, set the container on a surface approximately (2) feet off the ground. The drain valves must be turned OFF.
9. Disconnect the short hose from the SANITIZE inlet. Leave the colored valves in the SANITIZE position.
10. **Power Fill Water Tank:**

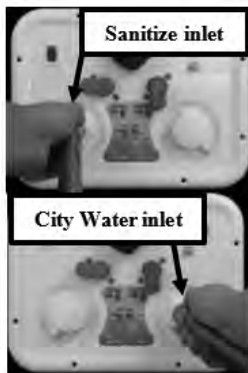

Attach your fresh water hose to the CITY WATER CONNECTION inlet at the utility center. Connect the other end of the hose to a pressurized water source. Turn the water on and finish filling the water tank with fresh water. **DO NOT OVERFILL THE TANK!** Use the LED indicators on the tank monitor inside the RV at the Command Center panel to monitor water level in fresh water tank.

### **Siphon Fill Water Tank:**

If there is no pressurized water source available, fresh water can be siphoned into the water tank from an external container (bucket). Fresh water hose should be connected to the SANITIZE inlet, other end of the hose placed in the bucket of water. Colored valves should still be in SANITIZE position. Turn the pump ON and water will be siphoned into the tank. **DO NOT OVERFILL THE TANK!** Use the LED indicators on the tank monitor at the Command Center to monitor water level in fresh water tank.

11. When the tank is full, turn off the water source. Disconnect the hose from the faucet/spigot first. Then disconnect the hose from the utility center panel.

At this point the following conditions should be met:

- Power to the water heater is OFF.
- Water filter has been bypassed or removed (depends on model).
- Sanitizer has been put into the tank.
- Water tank is full having been topped off with fresh water.



12. Set the valves to the **DRY CAMPING** setting.
  - Green valve points down
  - Blue valve points to the right
  - Water Heater Bypass valve is still set to **BYPASS**.
13. Turn the water pump ON and sanitized water will flow into the water lines from the water tank (when a fixture is opened).
14. Open hot water faucets one by one until water begins to flow continuously and a chlorine smell is noticeable. Close hot water faucets. Repeat this process with the cold water faucets. Include outside shower faucets (if so equipped) and outside kitchen faucets as well (if equipped).
15. Turn OFF the water pump.
16. Let the solution remain in the tank and lines for at least four hours when disinfecting with 50-PPM residual chlorine. If a shorter time period is desired, then a 100-PPM chlorine concentration should be permitted to sit in the system for at least one hour.



**NOTE:** To thoroughly sanitize the fresh water tank, the unit should be driven around for a short distance allowing the solution to splash the sides and top of the tank.

17. After the required period, drain the chlorine solution from the fresh water system.

### Rinse the system with fresh water:

1. Fill the fresh water tank full of clean (potable) water. Use water either from a pressurized source, or from a container (as detailed below).
  - a). **Filling from a pressurized source:** Attach your fresh water hose to the CITY WATER CONNECTION inlet at the utility center. Connect the other end of the hose to a pressurized water source. Colored valves should be in the TANK FILL position. Turn the water on and finish filling the water tank with fresh water. **DO NOT OVERFILL THE TANK!** Use the LED indicators on the tank monitor inside the RV at the Command Center panel to monitor water level in fresh water tank.
  - b). **Syphon filling from a water container:** Fresh water hose should be connected to the SANITIZE inlet, other end of the hose placed in a bucket of water. Colored valves should be in SANITIZE position. Turn the pump ON and water will be siphoned into the tank. **DO NOT OVERFILL THE TANK!** Use the LED indicators on the tank monitor at the Command Center to monitor water level in fresh water tank.
2. Power to water heater should be OFF (electric and LP Gas switches on standard storage water heater). Set the red water heater bypass lever to **NORMAL**. (lever points left)
3. When the fresh water tank is full, set the valves to the **DRY CAMPING** setting. Turn the pump ON to send water through the lines.



Water Heater Bypass

## SECTION 8: PLUMBING SYSTEM

4. Run water through all faucets (hot and cold, including outside shower and outside kitchen) until chlorine smell is gone. Turn all faucets and outside shower off, turn pump OFF.
5. Drain the fresh water system again. If the RV has the full system canister water filter, remove the canister, reinstall the filter, and reattach the canister.
6. Refill the fresh water tank with fresh water again and when water heater is full of water, turn the water heater power ON. Water heater is full if you open a **HOT** water faucet and water comes out in a steady stream.

**Lingering Chlorine Taste:** If a chlorine taste lingers in the water, flush the water system with a solution consisting of one-quart vinegar to five gallons of clean water. Re-flush as necessary. The vinegar solution may damage the water heater or the water filter. Remove the canister water filter and bypass the water heater. **Set water heater bypass lever to BYPASS** (pointing up).

Follow the steps outlined in *Draining the Fresh Water System* with one exception: **do not drain the water heater. Do not remove the water heater drain plug.**

For the **full system canister** water filter: remove the canister, take out the filter, then re-attach the empty canister.

### **After draining the system:**

1. For a tank type (storage) water heater, the power should still be OFF (both electric and LP Gas switches).
2. Put the vinegar solution into the fresh water tank.

Set the colored valves to the **SANITIZE** setting.

- Green valve points left
- Blue valve points down

Attach a short hose to the **SANITIZE/WINTERIZE** inlet. Put the other end of the hose in a container with the vinegar solution. Do **NOT** use your fresh water hose for this.

Turn the water pump ON. The solution will be drawn into the fresh water tank. When the container is empty, turn pump OFF, and disconnect hose from utility panel.

To aid in siphoning, place the container approximately (2) feet off the ground. The drain valves must be closed.

3. Fill the fresh water tank full of clean (potable) water. Use water either from a pressurized source, or from a container (as detailed in Step 18).
4. Set the valves to the **DRY CAMPING** setting. Turn the pump ON to send water through the lines. Run water through all faucets (hot and cold, including outside shower and outside kitchen if applicable) until chlorine smell is gone.
5. Close all faucets including outside shower and outside kitchen (if applicable). Turn pump OFF.
6. Drain the system again, but do not drain the water heater (water heater power still OFF and water heater is bypassed).
7. Close low point drains and fresh water tank drain.
8. Refill the fresh water tank with clean potable water. Use the **CITY WATER CONNECTION** inlet or **SANITIZE/WINTERIZE** inlet depending on which fill method you use explained in Step 18 previously.



**Water Heater Bypass**



9. Open faucets and check that the chlorine smell is gone.
10. Drain the system one more time.
11. Replace the water filter:  
**Canister filter:** Turn off water valves at the canister filter. Remove canister lid, put filter back into canister, and replace the canister lid. Turn water valves back on.  
**Cartridge filter:** Remove the clear plastic bypass tube and replace the water filter cartridge.
12. Reset the water heater bypass valve to **NORMAL**.
13. Refill the water tank using one of two methods from Step 18 previously. All drain valves should be turned OFF.
14. After filling the water tank, set the valves to either DRY CAMPING (which uses the water pump) or CITY WATER (which uses pressurized water) to send water through the plumbing system. For an explanation of valve settings, which inlet to hook up to, etc. refer to *Using the Uni-Doc Utility Center*.



**Water Heater Bypass**

### Winterizing the Plumbing System

Preparing your recreation vehicle for colder weather or storage is very important for most states and Canada. Failure to prepare your RV may cause water supply lines and the water heater to freeze. The RV should be winterized at the end of the camping season or when it will be exposed to temperatures that will fall at or below 32°F (0°C). Repairs due to freezing are not covered by warranty.

**NOTE:** The winterization process may vary slightly due to different plumbing configurations between models.

**NOTE:** Appliances (refrigerator, dishwasher or clothes washer) must be winterized. Refer to the appliance owner's manual for possible additional information or contact your Dealer or Customer Service for assistance.

If you choose to perform the winterization process yourself, read and understand the following information before starting. Contact customer service or your dealer for questions about this process. Refer to the *Using the Uni-Dock Utility Center* section for valve settings. It may be easier to winterize the RV with the aid of a second person.

**NOTE:** The water heater must be drained to prevent damage from freezing. There is a separate water heater bypass valve at the utility center. **Do not drain the water heater while it is hot or under pressure!** Antifreeze should be kept out of the tank (storage) water heater.

## SECTION 8: PLUMBING SYSTEM

The preferred method to winterize your recreation vehicle is by using RV antifreeze in the plumbing system. It may be easier to winterize the RV with another person to assist you.

### **⚠ CAUTION**

If the recreation vehicle is going to be stored in a non-temperature controlled environment with a risk of temperatures reaching 32°F (0°C) or lower, the plumbing system **must** be winterized with RV antifreeze. Repairs due to freezing are not covered under the terms of the **Towable Limited Warranty**.

### Winterize with Air Pressure

This method uses compressed air to blow out any remaining water in the system after initially draining water lines using drain valves. **Tools required would be an air compressor and a blowout plug.**

### **⚠ WARNING**

**Before applying air pressure to the utility center**, the 2 colored valves (GREEN and BLUE) **MUST** be set to 45° or damage may occur to the utility center.

Never apply air pressure to the water system with any of the valves in the closed position. Air pressure applied to a closed valve, faucet or low point drain could potentially damage the seals and cause water leaks. If you have questions, consult your RV dealer. Using RV antifreeze is the preferred method of winterization.

**Recommended air pressure is 30 PSI MAX. Exceeding this pressure may rupture water line couplings and void your warranty.**

1. Water heater power should be OFF (ELECTRIC and GAS switches). The switches are located inside the RV at Command Center panel.
2. The water heater bypass valve should be set to **NORMAL**. Lever pointing to the left as shown.
3. Level the RV and drain the fresh water tank, the tank (storage) water heater and the hot and cold water lines. Open all low point drains and the fresh water tank drain. Faucets inside the RV should be opened to relieve pressure to allow water lines to drain. Refer to *Draining the Fresh Water System* section.
4. If your RV has a Spray Port on the outside of the trailer, this port should be drained at this time. Refer to *Winterize the Spray Port* section for the procedure.
5. Remove the drain plug from the tank (storage) water heater located outside the RV ). **Do not remove the drain plug if the water heater is hot or under pressure. Release pressure and let it cool down.**
6. Water filter should be removed for winterizing. See *Water Purification System* section.



**Water Heater Bypass**



**Fig 1: Water Heater Drain Plug**

Your RV may have one of two types of filters:

**Full System Canister Filter:** Remove the canister lid, take out the filter and then re-attach the lid on the empty canister.

**Cartridge Water Filter:** Remove the cartridge filter and replace it with a bypass hose (supplied with your RV).



**NOTE:** Filters should be replaced at the beginning of the camping season or if they have been exposed to contaminated water, sanitizer or antifreeze.

7. Turn the (color) valve handles to the TANK FILL position.
  - Green valve points left
  - Blue valve points down
8. Low point drains should be open to remove water from the lines.
9. Open all faucets in the RV. If there is an outside shower, attach the shower hose to the shower, and open shower faucets. If there is a sink at the outside kitchen, open those faucets as well.
10. Run the water pump until pump is dry (approximately 15 to 20 seconds). Do not operate pump longer than that without water, it can damage the pump.
11. After water is drained from the lines, turn the Green and Blue valves so they are at 45° (**Fig 2**).
12. Attach a blowout plug to the City Water Inlet on the utility center panel.
13. Attach the air hose to the blowout plug. Set the compressor to **30 PSI**. **Green and Blue valves must be set at 45° before applying air pressure 30 PSI Max.**
14. Blow air into the utility center (30 PSI Max). Water lines should be clear in 5 to 10 minutes.
15. Turn off air supply, remove air hose and blowout plug.
16. Close low point drains, replace the water heater drain plug.
17. Set the water heater bypass valve to the **BYPASS** position. Red lever points up as shown.
18. Set the colored valves to the **WINTERIZE** positions.
  - Green valve points left
  - Blue valve points right



**Fig 2: Set 2 Valves to 45°**



**Blowout Plug**



**Water Heater Bypass**

### **Winterize the Black Tank Flush**

1. Black tank should be empty prior to winterizing.
2. Rinse the black tank prior to blowing it out with air.
3. Attach the 4" sewer hose to the dump connector under the RV.
4. Open the waste gate valve for the black tank (under the RV).



## SECTION 8: PLUMBING SYSTEM



**NOTE:** If the RV has a macerator system, you need to open the bypass valve for the macerator under the RV. This will allow the black tank to drain through the 4" sewer hose.

5. Attach a garden hose to the TANK FLUSH inlet at the utility center.
6. Attach the other end of the hose to a pressurized water source. Turn water on.
7. Flush tank until water appears clear in 4" sewer hose.
8. Turn off water, disconnect the hose from faucet, disconnect hose from tank flush.
9. Connect the blowout plug to the Black Tank Flush inlet at the utility center panel.
10. Colored valves have no effect on the black tank flush inlet.
11. Connect the air hose to the blowout plug. Set the compressor to **30 PSI maximum**.
12. Open the black tank drain gate valve, macerator bypass valve is open also.
13. Blow air into the flush inlet for 30 to 60 seconds.
14. Disconnect the air hose, compressor and blowout plug.
15. Close the black tank drain gate valve and close the macerator bypass valve.

### Draining the Spray Port

1. With fixtures and drain valves open in the RV to drain the water lines, connect the blue-coiled hose to the brass quick connect fitting at the Spray Port.
2. Remove the spray nozzle from the other end of the hose.
3. Hold the open end of the hose near the ground and any water in the line should drain out.
4. Disconnect the hose from the fitting, and store in the RV.
5. Close the port cover.



Spray Port

### Winterizing the Spray Port with Antifreeze

1. As you are putting antifreeze into the water lines, attach the hose to the Spray Port.
2. Have a container close by to capture antifreeze.
3. Pull the trigger on the spray nozzle until antifreeze comes out (into the container).
4. Release the nozzle and disconnect the hose from the port.
5. Rinse out the hose before storing it.



Spray Port Hose

### Winterize with Antifreeze Method

## **⚠ WARNING**

Automotive antifreeze (ethylene glycol) and windshield washer antifreeze (methanol) are poisonous. Never use these products in your fresh water system. These products are harmful and may be fatal if swallowed.

Requires non-toxic RV antifreeze in the water lines and does not require any special tools. Use **ONLY RV ANTIFREEZE** in your fresh water system for freeze protection.

No other product or commodity should be used. Antifreeze should **never** enter the water heater, RV water filter, refrigerator, refrigerator water filter, or fresh water tank.

## SECTION 8: PLUMBING SYSTEM

1. Turn water heater power OFF. The Gas and Electric switches inside the RV at the Command Center should be OFF. **The water heater should never be drained when HOT or under pressure.**
2. Level the RV and drain the fresh water plumbing system. Refer to *Draining the Fresh Water System*.
3. Water heater should be empty after draining the plumbing system. The drain plug must be removed from the water heater (**Fig 1**). Water heater bypass valve should be set to NORMAL.
4. Remove water filter:  
**Cartridge Style:** Replace filter with the bypass tube supplied with the RV.  
**Canister Style:** Remove the lid, remove the filter, replace the lid.



**NOTE:** Appliances (refrigerator, dishwasher or clothes washer) must be winterized. Refer to the appliance owner's manual for possible additional information or contact your Dealer or Customer Service for assistance.

5. Make sure the “fresh water tank drain” and “low point drains” are **closed**. This includes the refrigerator/washer low point drains (if equipped).
6. Set the colored valves to WINTERIZE setting:
  - Green valve points left
  - Blue valve points right
  - Water heater bypass valve should be set to **BYPASS**. Red lever should be pointing up.
7. Attach a short hose to the SANITIZE/WINTERIZE inlet. Place the other end of the hose in a container of antifreeze. **Do NOT** use your fresh water hose for winterizing.
8. Turn the water pump ON with the pump switch on the utility center panel. Antifreeze will be drawn into the water lines when a fixture in the RV is opened. To aid in siphoning, place the container approximately (2) feet off the ground. The drain valves must be closed.
9. Open the hot water faucets one at a time (kitchen/bath sinks, shower, outside shower and outside kitchen (if equipped) until RV antifreeze begins to flow continuously. Then close each faucet.
10. Repeat with all the cold water line faucets (kitchen/bath sinks, shower, outside shower, and outside kitchen (if equipped)).



**Water Heater Bypass**

**Toilet:** Flush the toilet several times until you see antifreeze in the bowl.

### **When you are finished adding RV antifreeze:**

11. Turn the water pump OFF with the switch on the utility center panel.
12. Remove hose & container from the SANITIZE/WINTERIZE inlet. Put the cap back on the inlet. Leave the colored valves in WINTERIZE position.
13. Water heater bypass valve should remain in **BYPASS** position.
14. Pour 1 cup of RV antifreeze into any/all drain P traps (sinks and bathtub).

## SECTION 8: PLUMBING SYSTEM

15. Wipe any RV antifreeze out of the sinks, shower (or tub), toilet, washing machine tub, and dishwasher tub with a soft, dry cloth.

Contact your dealer if you require further assistance.

### **CAUTION**

Water can accumulate in the flexible hose and dump connector of the macerator system. When winterizing the RV, antifreeze must be added to the macerator system.

#### Winterize the Macerator system (if so equipped)

1. **Ensure all waste tanks are empty.**
2. Pour RV antifreeze into the toilet and down into the black water tank.



**NOTE:** Use a container (bucket) for capturing system fluid.

3. Make sure macerator bypass valve is pulled OUT. Turn the macerator pump ON.
4. Run the pump until antifreeze begins to discharge from the dump connector attached to the flex hose.
5. Turn the macerator pump OFF.
6. Drain the flex hose by holding it at a sloped angle to drain excess water and return the hose to the storage location.
7. As an added safety measure, open the Macerator Bypass valve and let it drain. Push the valve IN to bypass the macerator. The bypass valve may be either at the utility center or under the RV.
8. After draining make sure to pull the macerator bypass valve OUT again.



**Utility Center**

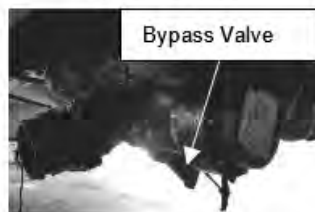

**Under Motorhome / RV**



**NOTE:** The bypass valve for the macerator is typically pointing back underneath the coach. Handle position is normally pulled OUT (bypass closed). The valve position is by design, so it can't be activated accidentally when system is operating normally.

**De-winterize the macerator system:** Emptying the black tanks in the spring will flush antifreeze out of the macerator system.



**WATER HEATER****⚠ WARNING**

- Hydrogen gas may result if you have not used the water heater for two weeks or more. **HYDROGEN GAS IS EXTREMELY FLAMMABLE.** To reduce the risk of injury under these conditions, open the hot water faucet for several minutes at the kitchen sink before you use any electrical appliance connected to the hot water system. If hydrogen is present, you may hear what sounds like air escaping through the pipe as the water begins to flow. Hydrogen gas may be present even after water has been drained from the water heater tank. Open the faucet at the sink and allow the system to vent for five to ten minutes. Do not smoke or have any open flame near the open faucet while venting. On DSI water heater models, make sure the switch is OFF.
- Do not alter the operation or change the design/construction of your water heater. For your safety, only factory authorized parts should be used on your water heater. Accessories marketed for recreation vehicles, such as an “add-on” electric heating elements, are not recommended by the manufacturer. Such items are not approved to be installed and could create an unsafe condition and will void all warranties
- **If you smell propane gas then STOP!** and follow the procedures listed in the *Propane System* section before attempting to operate the water heater.

Your RV may be equipped with either a tank (storage) water heater or tank less water heater. The following is an overview of both systems. For detailed operating instructions, refer to the manufacturer’s owner’s manual.

**Gas/Electric DSI Tank (Storage) Water Heater System (if so equipped)**

Read the safety and operating information in the manufacturer’s user guide before attempting to activate the water heater. Make sure the water heater is filled with water before use as even momentary operation of the water heater without water in it may result in damage to the tank and/or controls. Always open both the hot and cold water faucets when filling the fresh water tank to allow air pockets to be forced out of the water heater.

The water heater manufacturer has preset the sensing limit to maintain the water temperature when the water heater is activated. The thermostat on your water heater is not adjustable and is designed to maintain a water temperature of 130°F (54°C).

The water heater does not have a pilot. It is equipped with an ignition device which automatically lights the burner. Do not try to light the burner by hand.

**Operating instructions**

1. Turn OFF all electric power to the water heater.
2. Turn OFF the propane supply.
3. Wait five minutes for the propane to clear the area. **If you smell propane STOP!** Follow the safety instructions listed in the manufacturer’s owner’s manual. If you do not smell propane, go to the next step.
4. Turn ON the propane supply.
5. Turn ON electrical power to the water heater.
6. Turn the switch to the “ON” position. If the burner does not light, the system will

## **SECTION 8: PLUMBING SYSTEM**

automatically attempt two more tries for ignition before lock-out occurs. NOTE: *Each ignition cycle will have a 15 second purge before spark cycle if the system is a three try system.*

7. If lock-out occurs before the main burner lights, turn the water heater control switch to OFF, wait five seconds and turn the switch to the ON position. This will restart the ignition cycle.
8. The first start-up of the heater may require several ignition cycles before all the air is purged from the propane lines.

If the burner will not come on, the following items should be checked before calling a service person:

1. See if the switch is turned OFF.
2. Make sure the propane supply to the water heater is not empty or turned OFF.
3. Check to see if the reset button on the water heater ECO is tripped.

### **Water Heater Bypass (if so equipped)**

Your RV may be equipped with a water heater bypass. This three-valve system is located at either the water heater, or on the utility center panel depending on your model. For detailed information see the *Water Heater Bypass* section.

### **Odor from the hot water system**

Many water supplies contain sufficient amounts of sulfur to produce an odor, often called “sulfur water”. Sulfur water can be caused by a chemical action or by bacteria. Generally, sulfur water is not harmful, only unpleasant to smell. Refer to the water heater manufacturer’s owner’s manual for details on eliminating the odor from sulfur water. Odor from sulfur water is not a service problem.

## **⚠ WARNING**

Do not replace anode rod or any other component with an accessory part that is not authorized by the water heater manufacturer, such as an “add-on electric heating element. Such items are not approved to be installed and could create an unsafe condition and will void all warranties

### **Anode rod protection**

The tank in the water heater is protected by a magnesium or aluminum anode to prolong the life of the tank by absorbing the corrosive action of hot water. Under normal use, the anode rod will deteriorate and because of this, the water heater OEM recommends the anode rod be replaced yearly. Water with high levels of iron and/or sulfate will increase the rate of deterioration; therefore, more frequent replacements may be required.

If an anode rod is mostly eaten away, replace it with a new one. The water heater manufacturer recommends replacement of the anode rod when consumption or weight loss is greater than 75 percent.

Operating the water heater without the proper anode rod protection will decrease tank life and will void the tank manufacturer’s warranty on the tank. To extend the anode life, drain the water from the water heater tank whenever the RV is not being used. Avoid any extended time of non-use with water in the tank.

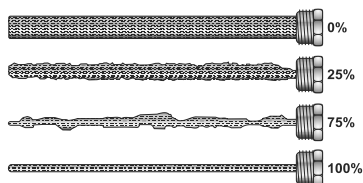

**Anode Rod Replacement Chart**

To prevent a water leak when replacing the anode rod, a pipe thread sealant approved for potable water (such as Teflon tape) must be applied to the threads of the anode rod. Proper application of a thread sealant will not interfere with the anode's function.

### **High altitude deration**

Operation of the water heater at high altitudes may require derating. If the water heater is not properly derated, lack of sufficient oxygen for combustion may produce improper burner operation. Pilot outage caused by burner lift-off or sooting from a yellow burner may occur, indicating the possibility of carbon monoxide. You may also notice a lack of efficiency in heating the water because of incomplete combustion of the burner at these higher altitudes. Consult with the local propane company, your dealer or the water heater manufacturer for proper derating of the water heater. Change out of the orifice (derating) should be done by the dealer or a qualified service agency.



**NOTE:** It is important that once the RV has returned to lower elevation (below 4500 feet) any high altitude deration or other adjustments be reversed for proper operation of the water heater.

### **Pressure and temperature relief valve**

## **WARNING**

Do not place a valve between the pressure and temperature (P&T) valve and the tank. Do not remove or plug the relief valve under any circumstances.

The temperature and pressure relief valve is designed to open if the temperature of the water within the heater reaches 120° F, or if the water pressure in the heater reaches 150 pounds. When this pressure is reached, the pressure relief valve will open and water will drip from the valve.

This “weeping” or dripping will continue until the pressure is reduced to below 150 pounds, and the valve closes. This condition is normal and does not indicate a defective relief valve.

One way to reduce the frequency of this occurrence is to maintain an air pocket at the top of the water heater tank. This air pocket will form in the tank by design; however, it will be reduced over time by the everyday use of your water heater. To replenish this air pocket:

1. Turn off the water heater.
2. Turn off the cold water supply line.
3. Open a faucet in the RV.
4. Pull out the handle of the pressure relief (P&T) valve and allow water to flow from the valve until it stops.
5. Release the handle on the P&T valve - it should snap closed.

Close the faucet and turn on the cold water supply. As the tank fills, the air pocket will develop. Repeat this procedure as often as needed to reduce the frequency of the weeping P&T valve.

## **SECTION 8: PLUMBING SYSTEM**

### **Maintenance**

Do not allow the burner to burn with a yellow flame, or continue to operate the water heater with an improper burner flame.

Periodically, inspect the water heater vent for soot. Soot is a sign of incomplete combustion and must be corrected before operating the water heater. This is your visual warning that the water heater is operating in an unsafe manner. If soot is present, immediately shut the unit down and contact your dealer or a qualified service agency.

Periodically inspect the vent for obstructions. Do not terminate the vent on your water heater inside of add-on rooms, screen porches or patios. Doing so will result in products of combustion being vented into the rooms or occupied areas.

### **Draining and winterization:**

If the recreation vehicle is to be stored over the winter months, the water heater must be drained to prevent damage from freezing. Damage to the water heater caused by freezing is not warrantable. It is recommended the water heater be drained and bypassed during the winterization process, **particularly if introducing RV antifreeze into the plumbing system. Never drain the water heater when it is HOT or UNDER PRESSURE.**

### **To drain the water heater:**

1. Turn off electrical power to the water heater either at the switch from the electrical element or at the breaker.
2. Shut off the propane supply to the water heater.
3. Turn off the water pump.
4. Open both hot and cold water faucets.
5. Remove the anode rod from the tank.

For detailed information see the *Winterizing the Plumbing System* and *Water Heater Bypass* sections of this manual.

### **Tankless Water Heater (if so equipped)**

Your RV may be equipped with a tankless water heater. The tankless water heater uses less LP gas than storage tank model water heaters since it only uses energy when hot water is demanded. There is no pilot light to burn when no hot water is needed. The tankless water heater supplies an unlimited supply of hot water on demand (once lines are purged of standing water). As hot water is used, the cold water enters the heater. A water flow sensor detects the flowing water and automatically ignites the burner. Water circulates through the heat exchanger and is heated to the set temperature. When the tap is closed, the unit shuts down.

The tankless water heater does not require an anode rod to prevent corrosion, or a by-pass valve for winterizing. It is not affected by high altitudes.

The output temperature of the water depends on the temperature of the inlet water AND the amount of hot water that is drawn. If the inlet water temperature is over 65°F the tankless water heater will generate water in the range of 105°F to 120°F (on low flame) depending on the water flow selected by the user.

### **Operating Tips**

- Purge air out of ALL hot and cold water lines.
- Open the water heater door and turn the power switch “ON”.
- Set GMC (gas modulator dial) to appropriate setting.
  - Normal weather – set dial to the middle area.
  - Extreme cold weather – set dial to the extreme right (large flame).
  - Extreme hot weather – set dial to the extreme left (small flame).

- Open hot water faucet to a medium water flow. It may take a few seconds for the water to travel from the water heater to the faucet.
- To reduce temperature:
  - Turn GMC dial “counter-clockwise”.
  - Increase hot water flow.
  - Gradually add cold water.
- To increase temperature:
  - Turn GMC dial “clockwise”. NOTE: Use caution not to increase the dial too much which could cause the hot water temperature to rise to the point the water heater “limits” and turns OFF the flame (flame shut off is approximately 131° F).
  - Reduce hot water flow.

**For detailed operating information**, refer to the manufacturer’s owner’s manual.

### **Winterization**

Freezing of the water heater and its plumbing components will result in severe damage not covered by warranty. For this reason it is advisable to follow the recommendation(s) below if the unit is to be stored in a freezing environment or for long periods of time. At the start of the winter season or before traveling to a location where freezing conditions are likely, the unit must be winterized.

The very small amount of water present in the heat exchanger **DOES NOT** require the installation of a bypass kit. Refer to the *Winterization* section for details.

### **Pressure - Temperature Relief Valve**

 <b>WARNING</b>
<b>SCALDING INJURY-EXPLOSION</b>
<ul style="list-style-type: none"><li><input type="checkbox"/> Valve is not serviceable; if defective it must be replaced.</li><li><input type="checkbox"/> Tampering with valve will result in scalding injury. Do not place a plug or reducing coupling on outlet part of valve. If you use a discharge line allow complete drainage for both valve and line.</li><li><input type="checkbox"/> Tampering with valve will void the warranty.</li></ul>

**THIS VALVE IS A SAFETY COMPONENT AND MUST NOT BE REMOVED FOR ANY REASON OTHER THAN REPLACEMENT.**

**THE PRESSURE RELIEF VALVE SHOULD ONLY BE REPLACED BY A QUALIFIED SERVICE TECHNICIAN.**

### **Maintenance**

Inspect your water heater monthly and have it serviced at least once a year by the manufacturer’s recommended service technician. If you have further questions contact your RV dealer, the manufacturer, or Customer Service.

**For more information**, refer to the manufacturer’s user guide

### **OUTSIDE SHOWER (IF SO EQUIPPED)**

A handheld shower assembly with both hot and cold water may be included for use outside of your recreational vehicle.

1. Be sure the water heater is ON and had sufficient time to heat the water.
2. Open the outside shower compartment door.
3. If dry camping, be sure the 12-volt water pump is ON.
4. Remove the handheld shower from its holder.

## SECTION 8: PLUMBING SYSTEM

5. Turn ON the hot and cold faucet knobs, and adjust the water temperature as desired.
6. To activate the handheld shower turn ON the sprayer head attachment (some models). To turn off the water, **always** close the hot/cold control (faucet) knobs. The lever on the shower head will not completely stop the flow of water; this is intentional to allow for draining. After the water has been allowed to drain from the shower head, return it to the outside shower compartment. Any remaining water in the shower hose will drip or run out; this is not a leak but performs as intended. If you are dry camping, turn the water pump OFF. Turning off the water with the shower head lever can also create a condition where the hot and cold water will mix through the outside shower faucet, thereby reducing the temperature of the hot water. It can appear as though the hot water heater is not working properly.

### **FAUCETS**

The bathroom, kitchen and outside shower faucets operate much the same way as the faucets in your home. Make sure there is sufficient water available and the 12-volt water pump is turned ON before operating.



**NOTE:** There may be air in the water plumbing lines which needs to be bled out before a steady stream of water comes from the faucet.

### **BATHROOM TUB / SHOWER**

Keep the water heater and holding tank capacities in mind when using the fresh water system. The used water will drain through the plumbing pipes into the grey water holding tank.

- Be sure the water heater is ON and had sufficient time to heat the water.
- If dry camping, be sure your 12-volt water pump is ON.

### **⚠ WARNING**

Water temperatures over 125°F (49°C) can cause severe burns instantly therefore, be careful when using hot water. **Always test the water temperature before showering or washing.**

Unlike your home, the recreational vehicle does not contain a water pressure balance valve. If someone is using the shower, it is recommended that the fresh water system **NOT BE USED** until they are finished.

The shower faucet includes a vacuum breaker for the shower. There are two purposes for this breaker:

- To prevent siphoning water through the hose from another fixture.
- To prevent water from being retained in the hose.

The showerhead DOES NOT have a complete shut-off valve (the complete shut-off is at the faucet). The showerhead may drip slightly in the OFF position after use; this is normal and does not indicate a leak or defect.

### **Maintenance**

Refer the manufacturer's user guide or label instructions for detailed cleaning information. The tub/shower walls are made of ABS plastic material. Use a mild detergent soap and warm water to clean. Do not use gritty or abrasive particle soaps or scouring compound to clean ABS plastic. Avoid using "Citrus" or biodegradable cleaners which contain "D-Limonene". They will damage plastic materials. Contact your dealer for repair or replacement.

### **BLACK/GREY WATER SYSTEM AND TANKS**

Water from the sinks and shower flows into the gray water (or waste water) holding tank. Water from the toilet will flow into the sewage (or black water) holding tank (see *Black/Grey Water Holding Tanks*).

#### **Drain Pipes with P-Trap (if so equipped)**

The drain pipes may be equipped with a "P-trap" installed to help prevent odors from escaping into the RV. During travel, water from the P-traps may spill and permit odors into the RV. By adding water and using a RV approved deodorizing agent you will dissolve the contents faster and will keep the drain lines and tanks clean and free flowing. These chemicals are available at an RV supply store or your dealer.

#### **Drain Pipes with Dry Sealing Valve (if so equipped)**

Your RV may be equipped with a dry sealing valve that prevents the escape of odors from your waste system and eliminates the need for P-traps. Should the RV drain piping system become clogged and a mechanical cleanout tool is used to open the drain pipe, it is important that the dry valve be removed before passing the cleanout tool through the piping. Passing a mechanical cleanout tool through the waterless valve may cause damage to the internal seal that may potentially allow sewer gases to escape into the RV interior. The waterless trap can be unscrewed from the water lines. A label has been placed near the location of the waste valve that reads as follows:

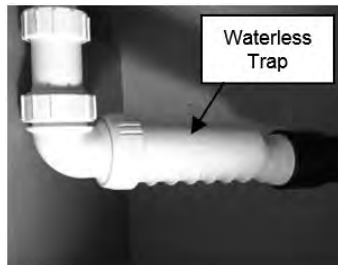

**REMOVE WATERLESS TRAP BEFORE  
USING MECHANICAL DRAIN CLEANING DEVICES**

### **Sewer Hose Storage**

Depending on your RV model, the sewer drain hose may be stored in an exterior compartment marked "Sewer Hose" or it may be located in the hollow square tube bumper. The bumper has removable plastic end caps, and the hose slides inside the hollow bumper.

### **Vents**

Another important part of this system is the vent pipes and vents that release air from the grey and black water holding tanks. On most models the exterior vent cap is attached to the roof and must be kept clear of obstructions to perform as intended. On some models, the vent pipe may be part of the drainage system referred to as a "wet vent" (water flows downward as air flows upward in the same pipe).

### **▲ CAUTION**

Keep drain valve closed to minimize the presence of sewer gases. Sewer gases may be present when RV is connected to campground sewage hookup. May lead to illness or personal injury.

## **SECTION 8: PLUMBING SYSTEM**

Some models are equipped with a side vent system. On these models this label will be next to the termination valve. This label should not be removed from your recreation vehicle.

### **Black/Grey Water Holding Tanks**

Dump the gray and black water holding tanks before traveling to avoid carrying unnecessary weight. The weight of the holding tank contents is not calculated into the RV cargo carrying capacity (this extra weight would reduce your available cargo capacity). Traveling with full holding tank(s) could possibly cause you to exceed the individual tire ratings and/or the RV GAWR or RV GVWR. Potential damage to suspension components, such as springs, tires and axles, could result.

If you are dry camping and cannot immediately empty your holding tanks, reduce your vehicle speed until you reach a dumping station. When connected to the sewer drain line at a campground, keep the “black tank drain” valve closed until the holding tank is at least  $\frac{3}{4}$  full. This will provide sufficient water to assist in complete draining of the black water holding tank. Repeat as needed.

### **WARNING**

Never travel with full black or grey water holding tanks. This not only wastes your fuel but depending on the location of the tank(s), it can affect your tow vehicle handling characteristics.

### **CAUTION**

- Never leave the black tank drain in the open position continuously when connected to the campground sewer system. Leaving the drain open will allow the liquid to drain out increasing the potential for a blockage in the tank. Keeping the drain in the closed position will prevent debris from accumulating in the tank.
- Do not add automotive antifreeze or caustic chemicals, such as laundry detergents, into the holding tanks. Although these products may have a deodorizing effect, they may damage the plastic and rubber parts of the plumbing system or the components

Before using the recreation vehicle, or after dumping the grey and black water holding tanks, always add the proper amount of deodorant to the black water tank to prevent odors and help break down holding tank contents (unless winterizing). Follow the deodorant bottle or package instructions. Driving to a disposal site will normally loosen any accumulated waste debris or solids from the sides of the holding tanks.

### **BLACK AND GREY TANK DRAINS**

There are labels on the exterior of the recreation vehicle indicating the location of the grey and black tank drains (also called dump valves). Always drain the black water holding tank first so the following grey tank waste water can help rinse any solids or debris from the dump outlet and sewer hose.



1. To make drainage easier, level the RV.
2. Remove the sewer hose housing dust cap, and attach the sewer hose (customer supplied).
3. Place the end of the sewer hose into the approved dump station.
4. Open the black tank dump valve (depending on your model the valve may be located under the RV, or on the utility center). Close the dump valve when the black water holding tank is empty.
5. Open the grey tank dump valve (depending on your model the valve will be located under the RV or on the utility center). Close the dump valve when the grey holding tank is emptied.
6. Remove, clean and store the sewer hose.
7. Close the sewer hose housing dust cap.



**Black/Grey Tank Drain and Valves**

You can locate many dump stations throughout the United States and Canada in Woodall's, Rand McNally Camp Guide, Good Sam Camp Guide, KOA Kampgrounds Camp Guide and various other publications. Some fuel stations also have dump stations. Please contact your RV dealer for assistance in the purchase and installation of a sewer hose or sewer hose extension (if needed).

### **Sewage (black) tank preparation**

#### **⚠ WARNING**

It is important to add enough water to prevent solid waste buildup. Follow the directions listed below and in the manufacturer's operator manual.

1. Release one to two quarts (1 or 2 liters) of water into the toilet bowl.
2. Follow the directions on your (RV approved) toilet chemical bottle (customer supplied), by placing the recommended quantity of holding tank chemical into the toilet bowl.
3. Flush the toilet and allow at least two gallons (8 liters) of water to flow into the holding tank.

### **Waste (grey) holding tank preparation**

No special preparation is required, however, placing a small quantity of chemicals into this tank, such as baking soda or an approved RV chemical, will reduce odors from food particles in the system.

### **Cleaning and Maintenance**

The toilet should be cleaned regularly for maximum sanitation and operational efficiency. Use only RV approved chemicals. Do not use chlorine (undiluted) or caustic chemicals, such as laundry bleach or drain opening types, in the toilet system. These products damage the seals in toilets and dump valves.

### **MACERATOR PUMP SYSTEM (IF SO EQUIPPED)**

Your RV may be equipped with a macerator pump system used to discharge waste from the gray and black waste tank. The system has a 1-1/2 inch diameter flexible hose that runs from the pump (under the RV) and is stored in an exterior storage compartment. The system when powered on can discharge waste (uphill if necessary) up to a distance of 150 feet.

### ⚠ WARNING

Before operating the macerator pump, make sure the external dump hose is properly attached at the RV and at the dump station. The hose is under pressure and therefore waste is discharged under pressure. **Failure to follow instructions can lead to possible injury or property damage. The use of this system for anything other than intended will void the warranty.**

### ⚠ CAUTION

Water can accumulate in the flexible hose and dump connector of the macerator system. When winterizing the RV, antifreeze must be added to the macerator system. Refer to the Winterizing section.

Open the hose compartment and pull out the 1-1/2 inch flexible hose (which can extend to 21 feet) with the attached dump connector. The dump connector includes two connections: a small removable cap for attaching a 3/4 inch garden hose, and a larger 3-inch removable cap that allows it to attach to the sewer outlet at the dump station.

#### Using the system

1. To make drainage easier, level the RV.
2. Attach the dump connector to the 3-inch sewer outlet at the dump station (Fig A), or to a 3/4-inch garden hose and run the hose to a dumping location.
3. Open the black tank dump valve.
4. Turn the Macerator power switch ON (switch lights up red) at the hose storage compartment and the macerator pump will begin sending waste through the dump hose.
5. When the tank is empty, turn the macerator power switch OFF. Close the black tank valve.
6. Select the gray drain valve.
7. Turn the Macerator Power Switch ON.
8. When tank is empty, turn the macerator power switch OFF. Close the gray tank valve.
9. Unhook the dump connector, rinse it out and replace the hose and connector back into the storage compartment.
10. The black tank flush inlet can be used with this system also (refer to the *Black Tank Flush section*).

The **Macerator Bypass Valve** is located underneath the external hose storage box. This bypass will allow you to gravity dump the waste from the tanks straight down to a 3-inch sewer hose connection under the trailer, in the event there is a problem with the macerator motor.

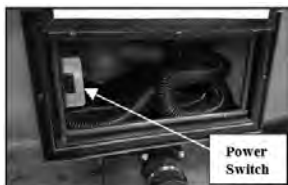

Macerator hose and dump connector



Garden hose connection



**NOTE:** The bypass valve also doubles as an emergency cutoff in the event of a problem with the flex hose or dump connector. Closing the valve stops waste flow out of the macerator pump and up to the flex hose, but will divert waste to the main dump connector under the RV. Make sure the main dump gate valve is closed until you are ready to empty the black tanks..

### To operate

1. Attach a 3-inch sewer hose to the main dump connector under the trailer and to a sewer outlet at a dump station.
2. Open the desired black / gray (manual) drain valves, one at a time (black then gray).
3. The macerator bypass valve will be pointing away from you and is attached to the macerator pump. The valve location is by design to prevent accidentally engaging the bypass when system is operating normally.
4. The bypass valve is normally open (handle is pulled **OUT**). To bypass the macerator, push the bypass valve **IN** (turns off flow from the macerator pump) allowing waste to flow out of the dump connector under the trailer via gravity.
5. When finished, close the main dump gate valve under the trailer, along with the black / gray dump valves. Disconnect the sewer hose from the main dump connector and at the dump station.



Macerator Bypass Valve

### ***BLACK TANK FLUSH (IF SO EQUIPPED)***

The black tank flush (no fuss flush) inlet is typically located on the utility center panel. The location may vary depending on your model. The inlet color may be either white or black. Attach a garden hose (connected to a pressurized fresh water source) to the black tank flush inlet. The water goes directly into the black water holding tank sprayer connection, allowing you to remove debris and preventing accumulation. There is a check valve in the plumbing lines to prevent back flow. Flush the black water tank each time the grey and black water holding tanks are dumped or as needed.

1. Dump the black water tank (see *Gray Tank Drain and Black Tank Drain*) and leave the black tank drain valve open.
2. Connect a garden hose from the water supply source to the black tank flush.
3. With the water source turned ON, flush the black water holding tank until the water running out of the black tank drain valve is clear (not discolored or cloudy).
4. Disconnect the garden hose and close the black tank drain valve. Fasten the sewer hose housing dust cap back on the tank flush inlet.



Tank Flush Inlet



**⚠ WARNING**

Do not use the same hose to fill your fresh (potable) water tank that is used for the black tank flush.

**TANK HEATERS (IF SO EQUIPPED)**

Your recreation vehicle may be equipped with heaters for the fresh, gray, black water tanks and the water lines or drain lines. The larger tank heaters are 120VAC and attach directly to the tanks. Water line or drain line heaters are smaller and operate on +12VDC and will be attached to the water lines or drain lines. These heaters will prevent water in the tanks and lines from freezing down to -11°F (-24°C) (contingent on recreation vehicle setup).

The tank heaters are thermostat controlled and will cycle on and off while they are operating. The +12VDC heaters stay on constantly. The thermostat controlled tank heaters turn ON at 44°F (7°C) and will turn OFF at 64°F (18°C). All of the heaters are controlled by a single ON/OFF switch.

Typically, this red tank heater ON/OFF switch is located on the command center panel or in the bathroom. The switch lights up red when it is turned ON and controls the heater circuit.

**NOTE**

- In order for the 120VAC tank heaters to be in operation, the recreation vehicle **MUST** be hooked up to shore power or under generator power.
- If the recreation vehicle is not operating on shore power or generator power, **only the +12VDC heaters will operate. This can result in the tanks freezing.**
- The red light on the command center tank switch does not necessarily indicate that **ALL** heaters are operating; it is only a warning that the heater circuit is ON.

**The tank heater switch should be turned ON:**

- When liquid is present in the holding tanks and the outside temperature approaches and maintains freezing conditions 35°F (2°C) or colder.

**The tank heater switch should be turned OFF:**

- When there is NO liquid present (tanks are empty).
- When dumping the black and gray holding tanks and the drain pipes.
- When fresh water tank and supply lines are empty or being drained for storage.
- When the recreation vehicle is connected to city sewer and the gate valves are open.



**NOTE:** Free draining is never recommended, especially in cold weather use.

- When ambient temperatures rise and remain above freezing.

## **SECTION 8: PLUMBING SYSTEM**

No maintenance on the heaters is required, only a periodic inspection for loose wires, damage, etc. For additional detailed information, refer to the tank heater manufacturer's user guide.

### **TOILET**

The toilet is efficient and easy to operate. Prior to using the sanitation system, it is strongly recommended to flush the toilet several times to release sufficient water into the holding tank. Generally, more water is required only when flushing solids.

#### **CAUTION**

- It is important to prevent solid waste buildup. Follow the toilet manufacturer's recommended instructions each time after emptying the black water holding tank.
- To prevent help toilet blockage, always use RV grade single-ply toilet paper. Do not flush paper towels, diapers, sanitary napkins or other foreign objects down the toilet.
- Do not use chlorine (undiluted) or caustic chemicals, such as laundry bleach or drain opening types, in the toilet system. These products damage the seals in toilets and dump valves.

The toilet system will perform better when water is run for ten to fifteen seconds after flushing to ensure that the waste will proceed to the bottom of the tank.

If there is not a sufficient amount of water used during flushing, the waste materials may not evacuate properly from the drain line to the tank. Clogged tanks and pipes could eventually occur. For added convenience and better sanitation system performance, it is advisable to always have four to six inches (10 - 15 cm) of water in the toilet. It is important to add enough water to prevent solid waste buildup. The following guidelines will help to prevent solid waste buildup.

#### **Sewage (black) tank preparation**

1. Release one to two quarts (1 or 2 liters) of water into the toilet bowl.
2. Follow the directions on your (approved RV) toilet chemical bottle (customer supplied), by placing the recommended quantity of holding tank chemical into the toilet bowl.
3. Flush the toilet and allow at least two gallons (8 liters) of water to flow into the holding tank.

#### **Cleaning and Maintenance**

The toilet should be cleaned regularly for maximum sanitation and operational efficiency.

For detailed information refer to the manufacturer's operator manual.

**SPRAY PORT (IF SO EQUIPPED)**

Your RV may include a Spray Port on the exterior door side of the trailer. This Spray Port provides a way to rinse items off outside the RV or can be used to extinguish a campfire. There are no faucets to control (cold only) water flow. Water flow is controlled by the pump if dry camping or city water if using pressurized water. There is a removable spray nozzle at the end of the coiled hose. The hose is typically stored under the bed.

**Using the Spray Port:** Connect the end of the blue coiled hose into the fitting on the Spray Port. It has a collar on the fitting which operates similar to an air hose fitting. Pull back the collar on the Spray Port fitting, insert the end of the hose into the collar and release. The hose locks into the fitting. With the water supply turned on, pull the trigger on the spray nozzle until you have the desired water flow.



**Spray Port Hose and Nozzle**

 **NOTE: DO NOT** use this as a potable water source.

The water line supplying water to the sprayer must be drained if the RV is being transported, stored or if freezing weather is expected. This water line can be winterized with RV anti-freeze. Refer to *Winterizing the Plumbing System* for instructions on draining and winterizing the Spray Port.

## **SECTION 8: PLUMBING SYSTEM**

**Notes:**



### **AIR CONDITIONER**

The air conditioning system is controlled by a thermostat. Cooled air enters the RV through the grill. Make sure you have sufficient power available before operating the air conditioner. Do not operate the air conditioner without the return air filter. Operating the system without the filter allows the lint and dirt that is normally stopped by the filter to accumulate on the cooling coil of the air conditioner. This also will lead to a loss of air volume, possible equipment damage and an expensive cleaning process.

#### **Roof Mount (if so equipped)**

A special foam gasket is placed between the roof material and the subframe of the air conditioner to guard against water leakage. The air conditioner is subjected to wind pressures along with motor vibration during normal operation. Inspect the mounting bolts for tightness to ensure there is no leakage or looseness at least annually. Re-tighten bolts when they are loose. **DO NOT** over tighten these bolts as it may damage this gasket. The air conditioner gasket is a wearable part that eventually will need to be replaced. To gain access to the bolts, remove the filtered panel cover on central air systems or the entire air box on non-central air conditioners.

#### **Wall Mount (if so equipped)**

Keep the air inlet grill and cabinet clean by wiping with a cloth dampened with warm water and a mild detergent.

#### **Heat Pump Operation (if so equipped)**

Set the thermostat for either electric or gas heat. On the electric setting, the heat pump will become the primary heat source as long as the interior temperature of the RV has not dropped 5° below the thermostat set point. If this occurs, the thermostat will automatically activate your gas furnace.

The furnace will continue as the heat source until the thermostat set point has been satisfied. At that point, the heat pump will again become the primary heat source.

**For additional information** refer to the manufacturer's owner's manual included in your warranty packet or consult your dealer.

### **POWER ROOF VENT (IF SO EQUIPPED)**

The 12-volt DC attic fan (or powered roof vent) allows fresh air to circulate through the recreational vehicle. Do not leave the attic fan open when the recreational vehicle is stored or unattended for long periods.

High winds, other unusual conditions or obstructions may prevent the dome from closing; the resulting leakage could cause non-warrantable damage.

To use your fan most effectively, close all vents and slightly open a window on a shaded side of your recreation vehicle. You are directing the air flow by opening a window.

**For additional safety and operating information** refer to the manufacturer's owner's manual.

#### **Control pad (if so equipped)**

The attic fan may be controlled by a control pad. The dome can be raised or lowered with the UP/DOWN buttons, and the speed of the fan is controlled by the ARROW buttons. It is also equipped with a rain sensor that will close the vent automatically when it rains. The rain sensor can be turned on/off by holding the DOWN button for 3 seconds.



**Attic Fan Control**

## SECTION 9: HEATING & COOLING

### ***CEILING FAN (IF SO EQUIPPED)***

---

#### **WARNING**

Be careful to avoid placing any object in the path of the ceiling fan blades!

Turn the ceiling fan ON/OFF using an interior wall switch. The 3-speed ceiling fan is controlled by the pull chain switch. The sequence of operation for the pull chain switch is: OFF, High, Medium, Low, OFF. The slide switch (located on the fan) controls the direction of operation (down for forward, up for reverse). **Stop the fan first before reversing the operation direction!**



**NOTE:** During cooler temperatures, set your fan settings to “low,” and set the fan to turn clockwise to pull warm air from the ceiling back towards the floor. In the summer, the fan should turn counter-clockwise to keep air moving.

**For additional information** refer to the manufacturer’s owner’s manual.

### ***FURNACE***

---

The furnace installed in your recreation vehicle is controlled by a 12-volt DC thermostat. Depending on your model, there may be up to two thermostats enabling you to control the temperature to your comfort level.

The furnace requires both 12-volt power and propane gas for full operation. Make sure you have sufficient power available before operating your furnace.

If you have any questions contact your dealer or Customer Service. A qualified RV technician should perform all furnace maintenance at least once a year (more often depending on furnace usage). Never attempt to repair the furnace yourself.

#### **Ducting and Return Air**

All heat discharges, registers and return air grills must be free and clear of obstructions. This includes all closeable registers that are intended to reduce airflow, do not shut it off completely.

** WARNING**

- The furnace should be inspected periodically (monthly during the heating season) for presence of soot on the vent. Soot is formed whenever combustion is incomplete. This is a visual warning that the furnace is operating in an unsafe manner. If soot is observed on the vent, immediately shut the furnace OFF and contact a qualified service agency. Operating the furnace under this condition could lead to serious property damage, personal injury or loss of life.
- To ensure your personal safety, do not obstruct or alter the furnace in any manner. Do not install screens over the vent for any reason. Screens will become restricted and cause unsafe furnace operation. For your safety, only the manufacturer's factory authorized parts should be used on your furnace.

***FIREPLACE (IF SO EQUIPPED)***

Your recreational vehicle may include an electric fireplace insert. For detailed operating and safety information, refer to the manufacturer's user guide.

## **SECTION 9: HEATING & COOLING**

**Notes:**

**MICROWAVE**

**⚠ CAUTION**

- To prevent damage, remove the turntable from the microwave when traveling.
- Make sure you are connected to a 120-volt power source.

**⚠ WARNING**

Never use the microwave cavity for storage. The microwave cavity should always be empty when not in use.

For details on operation, cleaning and safety information, refer to the manufacturer’s user guide.

**General Cleaning Microwave and Convection Microwave**

**IMPORTANT:** Before cleaning, make sure all controls are off and the microwave oven is cool. Always follow label instructions on cleaning products.

To avoid damage to the microwave oven caused by arcing due to soil buildup keep cavity, microwave inlet cover, cooking rack supports, and area where the door touches the frame clean.

Clean with mild soap, water and a soft cloth or sponge, or as indicated below.

- Grease filters: mild soap and water or dishwasher.
- Door and exterior: mild soap and water, or glass cleaner applied to paper towel.
- Control panel: sponge or soft cloth and water.
- Stainless steel (on some models): mild soap and water, then rinse with clean water and dry with soft cloth, or use stainless steel cleaner.
- Turntable: mild soap and water or dishwasher.
- Rack(s): mild soap, water and washcloth. Dishwasher cleaning is not recommended.

**Convection Microwave (if so equipped)**

The convection microwave bridges the gap between microwaving your food and conventional cooking. Make sure there is sufficient 120-volt power before operating the convection microwave (see *Calculating Electrical Load*) or details on operation and safety information, refer to the manufacturer’s user guide.

**COOKING SAFETY**

**In Case Of a Grease Fire**

**⚠ WARNING**

Do not attempt to use water to put out the fire. Water can spread some types of fire, and electrocution is possible with an electrical fire.

Grease is flammable. Never allow grease to collect around top burners or on the cook top surface. Wipe up spills immediately. Refer to Section 2 – Safety Precautions, for fire safety and fire extinguisher information.

## SECTION 10: APPLIANCES

### Cooking with Propane (if so equipped)

See the *Propane System Section* for important safety instructions. Refer to the manufacturer's owner's manual for detailed operating and safety instructions for all propane appliances.

### COOKTOPS: RANGE AND OVEN (IF SO EQUIPPED)

For detailed operating and safety information, refer to the manufacturer's user guide.

#### **WARNING**

- During and after use, do not touch or let clothing or other flammable material come in contact with the top burners (or heating elements), burner grates or other areas near the top burners or oven until they have had sufficient time to cool. These areas can get hot enough to cause burns.
- Never leave cooking food unattended. Turn pan handles inward, but not over the tops of the other range burners. Ensure that pans used are large enough to contain the food and avoid boil-overs. Heavy splattering or spills left on the cooktop can ignite and cause burns.
- If using glass, glass/ceramic, ceramic, earthenware or other glazed utensils (or cookware) verify it is safe for use on the top burners. Only certain types of utensils (or cookware) are suitable for surface or top burner use.
- Do not cover the oven vent openings while the oven is in operation.** Restricting the flow of combustion air will create an asphyxiation hazard.

#### **CAUTION**

Never use oven cleaners, chlorine bleach, ammonia or glass cleaners with ammonia. Always allow the cooktop to cool before cleaning.

### **Cleaning instructions**

Refer to the manufacturer's user guide included for detailed cleaning instructions.

### **General Cleaning**

- To avoid damage and possible burns, be sure the appliance is off and all parts are cool *before* handling or cleaning.**
- Use care to avoid steam burns if a wet sponge or cloth is used to wipe spills on a hot surface.
- Some cleaners can produce noxious fumes if applied to a hot surface.
- To prevent staining or discoloration, clean appliance after each use.
- If a part is removed, be sure it is correctly replaced.
- If a spillover occurs while cooking, immediately clean the spill from the cooking area while it is hot to prevent a tough cleaning chore later. Using extreme care, wipe spill with a clean, dry towel.

### **Electric Drop-In Cooktops (if so equipped)**



**NOTE:** Make sure you are connected to a 120-volt power source.

 **CAUTION**

Do not use aluminum foil on the electric range cooktop, as this material will damage the cooktop surface if it melts. Do not use aluminum foil under any circumstances on the electric range cooktop.

**Gas Drop-In Cooktops (if so equipped)**

Depending on your model, it may be equipped with either a 2 burner or 3 burner cooktop. The 2 burner match-light cooktop has two 6500 BTU/H burners with control panel.

The 3-burner piezo-igniter cooktop has (1) front 9000 BTU/H burner and two rear 5200 BTU/H burners. The 3 burner cooktop is also equipped with a control panel.

Refer to manufacturer's user guide for detailed operating and cleaning information.

**Kitchen Range and Oven (if so equipped)**



**NOTE:** To help reduce potential condensation or unwanted cooking odors, turn on the overhead kitchen roof vent or the range hood vent (if so equipped)

To prevent damage, always use the manufacturer's recommended size flat bottom pan(s). Generally, the pan should be large enough to cover the burner, but not be more than one inch larger than the burner grate.

Do not use a broiler pan, griddle or any other large utensil that covers more than one burner at a time. This will create excessive heat that may cause melting, sooting or discoloration.

The use of undersized pans could expose a portion of the heating element to direct contact and may result in ignition of clothing. Proper relationship of pans to burner will improve efficiency.

**Oven (if so equipped)**

The propane gas oven must have 12-volt power to operate. If you have any questions, contact your dealer or our customer service department. **Do not use the oven as a storage area.**

**Refer to the manufacturer's user guide for detailed operation, cleaning and safety information.**

***GAS BBQ GRILL (IF SO EQUIPPED)***

**⚠ WARNING**

- ❑ Be sure to read, understand and follow all information supplied with your recreation vehicle concerning the use of propane before operating the BBQ grill. The propane hose must be correctly connected before lighting the grill. Failure to follow instructions supplied by the grill manufacturer, or use of any components other than those originally supplied with the grill, could result in death or serious injury.
- ❑ **If you smell gas: Shut off gas to the appliance; extinguish any open flame; open lid; if odor continues, immediately call you gas supplier or your fire department.**
- ❑ The maximum weight limit for the bracket supporting your BBQ grill is 50 lbs. This limit includes the weight placed on the BBQ grill. Exceeding this weight limit could result in injury or property damage.
- ❑ The BBQ grill is for use outside of the recreational vehicle. **Never use this grill inside a compartment or inside of the recreational vehicle.** Before operating the BBQ grill, make sure that it is securely mounted on the support rail attached to the side of the recreational vehicle (if so equipped) or the bumper mounting bracket (if so equipped).
- ❑ The BBQ grill must be **COMPLETELY COOLED** before storing it. The grill should be cool to the touch before storing. Storing the BBQ grill before it is completely cool may result in serious injury or property damage.

**⚠ DANGER**

Always open hood before turning on gas and lighting burner, failure to open the hood before lighting could cause an explosion causing property damage, injury, or even death.

Depending on your model, your grill will be mounted with either a bumper mount system, or a rail mount on the side of your recreational vehicle.

**Bumper Mount (if so equipped)**

Your RV may be equipped with a rear bumper grill mount. There are several styles of bumper mounts, each one may be designed to fit a specific type of grill or RV. Complete installation instructions for each bumper mount and each grill are beyond the scope of this manual. Please refer to documentation supplied in your warranty packet or call Customer Service for mounting information.





**Rail Mount (if so equipped)**

- Hang the grill bracket on the aluminum mounting strip located on the side of the recreation vehicle.
- Open the (2) folding arms on the bracket making sure they lock in position.
- Slide the grill onto the (2) arms against the stops. Make sure the grill is fully on the arms. Arms will slide into the “T” bracket on each side of the grill.
- Insert the retaining pins into the arms.
- To remove the grill, remove the retaining pins and simply slide it off the bracket arms. Wait until grill has cooled down before removing it.



**Gas Grill and Mounting**



**Bracket on Support Rail**

**NOTE:** Grill weight is 26 lbs.

Refer to the grill manufacturer’s user guide for detailed operating and safety information.

**Gas BBQ Grill Prep (if so equipped)**

Your recreation vehicle may be equipped with a propane “quick-coupler” connection and support bracket for easy installation of the BBQ grill.

**Attaching the “Quick Coupler” Connection**

The “quick coupler” is directly connected to the RV propane system. The “quick-coupler” connection is equipped with a positive shut-off valve.

Place the “quick coupler handle in the OFF position and push back the sleeve. The valve handle must be OFF to make the connection.

1. Insert the plug and release the sleeve.
2. Push the plug until the sleeve snaps forward, locking the plug into the socket.
3. Turn the handle ON to allow propane to flow to the drop in stove.

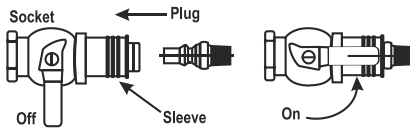

**Quick Connect Coupler**

**NOTE:** This outdoor cooking warning label should not be removed from the RV.

**⚠ WARNING**

When using this outdoor cooking area:

- The vehicle must be level and stabilized.
- Do not violate manufacturers’ instructions on required clearances for cooking appliances during use.
- Do not store cooking appliances until cool to the touch.

Can lead to a fire and explosion and result in death or serious injury.

AD-126

## SECTION 10: APPLIANCES

### ***RANGE HOOD (IF SO EQUIPPED)***

If your recreational vehicle is equipped with a range hood, it will be connected to an exterior vent.

The vent has an inner flap with two snaps. This flap can be snapped shut when the vehicle is in motion, or during storage to keep insects, debris, snow, rain, etc. from entering the recreational vehicle.

Anytime the stove inside the recreational vehicle is being used, this flap **MUST** be unsnapped and the range hood turned ON to vent fumes outside the vehicle.

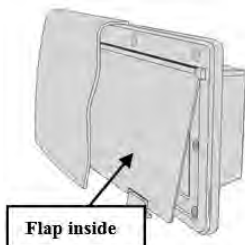

**Range Hood Vent**

### **⚠ WARNING**

Whenever the stove in the RV is being used: The range hood **MUST** be turned on, and the inner flap **MUST** be unsnapped and free to move. Failure to do so can create an asphyxiation hazard by restricting air flow to this vent.

### ***REFRIGERATOR***

The refrigerator is not intended for quick freezing or cooling. We recommend stocking it with pre-frozen or pre-cooled food when possible. The shelves should not be covered with paper or plastic and the food items should be arranged so air can circulate freely. Keep the area at the back of the refrigerator clean and free of debris. Check for obstructions in the exterior refrigerator vent area (i.e., spider webs, bird nests, etc.). Use a soft cloth to dust off the debris.

For optimum efficiency and performance, it is recommended the refrigerator be checked at least twice a year as part of the routine maintenance.

For detailed operating and safety information, refer to the manufacturer's user guide.

#### **Gas/Electric Models (if so equipped)**

### **⚠ WARNING**

If you smell propane gas **STOP!** Follow the directions located in your manufacturer's owner's manual and in this manual.

#### **Residential Models (if so equipped)**



**NOTE:** If you are using electric to power the refrigerator, make sure you are connected to a 120-volt power source.

**⚠ CAUTION**

The ice maker (if so equipped) should be turned off and the ice tray emptied when power to your recreation vehicle has been shut off. With no power, the ice will melt and water may “pool” in the refrigerator door. When power is restored, the vibration may cause this water to run out of the door and on to the vehicle floor.

**3-Way Refrigerators (if so equipped)**

Depending on your model, you may have a 3-way refrigerator (12VDC, LP GAS or 120VAC).

**⚠ WARNING**

Converter output (12VDC) is not intended for normal operation of the 3-way refrigerator. When the camping trailer is parked and the power cord is plugged in, set the 3-way refrigerator to “AC power.” The “DC mode” is to be used only when traveling and will pull power from the auxiliary battery charge line (if so equipped). When camping without available AC power, utilize the propane mode.

Contact your dealer or Customer Service for details on winterizing your refrigerator.

**Cleaning Your Refrigerator**

The following are general cleaning guidelines. For detailed information on cleaning your specific refrigerator, refer to the manufacturer’s user’s guide.

**Cleaning the Interior**

1. Unplug refrigerator or disconnect power.
2. Hand wash, rinse, and dry removable parts and interior surfaces thoroughly. Use a clean sponge or soft cloth and a mild detergent in warm water.
3. Inside the refrigerator, use a warm water and baking soda solution consisting of approximately 1-tablespoon (15ml) baking soda to 1 quart (1 liter) of water. This solution cleans and neutralizes odors. Rinse and wipe dry.



**NOTE:** Do not use abrasive or harsh cleaners such as window sprays, scouring cleansers, flammable fluids, cleaning waxes, concentrated detergents, bleaches or cleansers containing petroleum products on plastic parts, interior and door liners or gaskets. Do not use paper towels, scouring pads, or other harsh cleaning tools.

4. Leave an open box of baking soda in the refrigerator and freezer to help prevent odors. There is no need for routine condenser cleaning in normal operating environments. If the environment is particularly greasy or dusty, or if there is significant pet traffic, the condenser should be cleaned every 2 to 3 months to ensure maximum efficiency.

## SECTION 10: APPLIANCES

If you need to clean the condenser:

- Remove the base grille.
- Use a vacuum cleaner with a soft brush to clean the grille, the open areas behind the grille and the front surface area of the condenser.
- Replace the base grille when finished.

### Cleaning the Exterior

**Painted metal exteriors:** wash with a clean sponge or soft cloth and a mild detergent in warm water.

**Stainless steel exteriors:** wash with a clean sponge or soft cloth and a mild detergent in warm water. Do not use appliance wax, polish, bleach, or other products containing chlorine on stainless steel. Stainless steel can be cleaned with a commercially available stainless steel cleaner. A spray-on stainless steel cleaner works best.

**IMPORTANT: Do not allow the Stainless Steel Cleaner and Polish to come into contact with any plastic parts such as the trim pieces, dispenser covers or door gaskets. If unintentional contact does occur, clean plastic part with a sponge and mild detergent in warm water. Dry thoroughly with a soft cloth.**

For silver-accented plastic parts, wash with soap or other mild detergents. Wipe clean with a sponge or damp cloth. Do not use scouring pads, powdered cleaners, bleach or cleaners containing bleach as these products can scratch and weaken the paint finish.

### WASHER/DRYER PREP (IF SO EQUIPPED)

If your recreation vehicle was built with washer/dryer prep, be aware the cabinet space provided is intended for the installation of an aftermarket washer/dryer combo unit (customer supplied) only. Please consult your dealer or the manufacturer for installation assistance.

A dryer vent opening must be cut into the sidewall of the RV if installing a dryer. A label has been installed to assist you in placing the vent in the correct location. The label will be located in the area where the dryer will be installed. Instructions on how to cut the dryer vent hole and how to install the dryer vent in the wall of the RV are included in your warranty packet



Dryer Vent Label

### **⚠ WARNING**

Gas dryers should **NEVER** be installed in your recreation vehicle. Dryer prep has been designed for electric dryer operation **ONLY**.

### **⚠ CAUTION**

Do not operate a dryer in the recreation vehicle unless the dryer is properly vented.

### VACUUM SYSTEMS (IF SO EQUIPPED)

Depending on your model, one or both of the following vacuum systems may be in your recreation vehicle.

### Central Vacuum System

The following is an overview of the central vacuum system operation. For detailed operating and safety instructions, refer to the manufacturer's user guide.

The central vacuum system installed cleans virtually any surface with no electric cords and has a variety of attachments for many cleaning needs. Make sure you have 120-volt AC power available before operating your central vacuum system (refer to *Electrical Systems*, calculating electrical load).

To operate the central vacuum system lift the vacuum cover, and attach your vacuum hose and cleaning attachment. The central vacuum will automatically activate. It has a large disposable bag that will need to be checked periodically and replaced after usage. The disposable bag is located inside the exterior cargo compartment.

### **WARNING**

- DO NOT PICK UP ANYTHING THAT IS BURNING OR SMOKING, SUCH AS CIGARETTES, MATCHES, OR HOT ASHES. RV damage, personal injury, or death may result from vacuuming up burning or smoking material.
- DO NOT PICK UP FLAMMABLE OR COMBUSTIBLE LIQUIDS SUCH AS GASOLINE, OR USE IN AREAS WHERE THEY MAY BE PRESENT. RV damage, personal injury, or death may result from vacuuming up flammable or combustible material

### Rechargeable Vacuum

The portable vacuum is equipped with a rechargeable battery pack that can be plugged into a 120V AC wall outlet. Refer to manufacturer's user guide for important safeguards and operating instructions. Read all instructions before operating the vacuum cleaner.

## **WATER HEATER – SEE PLUMBING SECTION**

### **OUTSIDE KITCHEN (IF SO EQUIPPED)**

Typically outside kitchens consist of a 2-burner cooktop, refrigerator and sink. For detailed operation and safety information on the outside kitchen appliances, refer to the manufacturer's user guide.

The cooktop will function more efficiently when level.

### **WARNING**

The maximum weight capacity of the outside kitchen unit is 50 lbs. Setting items on the kitchen unit that exceed this weight limit could cause damage to the unit or result in personal injury.

Outside kitchen access and locking functions may vary depending on your model.

#### **The following applies when using any outside kitchen configuration.**

- Make sure all supports are securely in place before using the outside kitchen.
- Before using, make sure the propane connection is properly hooked up and secure.
- Do not leave the cooktop unattended while using.
- Keep all clothing and flammable material away from the cooktop while in use.
- Do not exceed the weight capacity of the outside kitchen unit.

## SECTION 10: APPLIANCES

- Disconnect the propane couple before stowing the outside kitchen unit.
- Make sure the kitchen unit is properly stowed and secured, and that the outside kitchen door is securely in place and locked before traveling.

### Attaching the “quick coupler” connection

The “quick coupler” is directly connected to the RV propane system. The “quick-coupler” connection has a positive shut-off valve as required by code and standards.

1. Place the “quick coupler handle in the OFF position and push back the sleeve. The valve handle must be OFF to make the connection.
2. Insert the plug and release the sleeve
3. Push the plug until the sleeve snaps forward, locking the plug into the socket.
4. Turn the handle ON to allow propane to flow to the drip in stove.

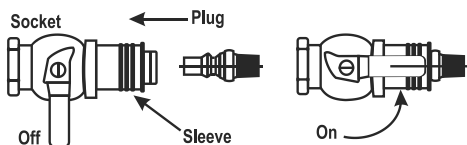

**Quick Connect Coupler**

**NOTE:** Outdoor cooking warning label should not be removed from the RV.

### **▲ WARNING**

When using this outdoor cooking area:

- The vehicle must be level and stabilized.
- Do not violate manufacturers' instructions on required clearances for cooking appliances during use.
- Do not store cooking appliances until cool to the touch.

Can lead to a fire and explosion and result in death or serious injury.

AD-126

### **Exterior Refrigerator**

Your recreational vehicle may be equipped with an exterior refrigerator in the front storage compartment, or in the outside kitchen (if so equipped). For information on use and safety, refer to the manufacturer's user guide.

### **LP Gas Grill (if so equipped)**

The outside kitchen may include an LP fueled BBQ grill. This grill is mounted in a pull out drawer. It has a single burner control. It attaches to the LP tank using a quick coupler connection as described above.



**NOTE:** A drip pan is included with the grill. The drip pan **MUST** be used underneath the grill to catch hot grease and liquids dripping from the grill and to prevent injury.

The drip pan attaches to tabs underneath the grill at each end. A handle is mounted in the middle of the drip pan to dump the contents. Refer to the grill user manual for further information.

This grill is *only* available on certain RV models.



**Drip Pan**

## **⚠ WARNING**

- The grill requires proper ventilation. It is designed for RV outdoor use only.
- NEVER** put lava rocks or charcoal or anything else on or under the grate. Grill is designed so it does not require those items. Serious injury or property damage can occur by placing foreign objects on the grate.
- Never touch the grate when it is hot.** Use the spade (grate handle) supplied with your grill.
- Be sure to read, understand and follow all information supplied with your recreation vehicle concerning the use of propane before operating the BBQ grill. The propane hose must be correctly connected before lighting the grill. Failure to follow instructions supplied by the grill manufacturer, or use of any components other than those originally supplied with the grill, could result in death or serious injury.
- If you smell gas: Shut off gas to the appliance; extinguish any open flame; open lid; if odor continues, immediately call you gas supplier or your fire department.**
- The BBQ grill is for use outside of the recreational vehicle. **Never use this grill inside a compartment or inside of the recreational vehicle.** Make sure the grill is pulled completely out of the drawer before attempting to use it.
- Install the drip pan under the grill to catch hot grease & liquids. Failure to use the drip pan can cause personal injury including burns from hot grease.
- The BBQ grill must be **COMPLETELY COOLED** before storing it. The grill should be cool to the touch before storing. Storing the BBQ grill before it is completely cool may result in serious injury or property damage.
- Do not cover the cooking surface with a dust cover, a lid, foil, cooking utensil or anything else. Covering the cooking surface can cause an unsafe situation and can lead to serious injury or property damage.

### **Cleaning The Grill**

**Make sure the grill is completely cool before cleaning.**

Use only non-abrasive cleaners or degreasers designed for use on stainless steel. Apply a stainless steel shine product to all external parts of your grill after cleaning.

Clean the cooking grid with soap and water and a wire brush after each use. Drip pan under the grill should also be cleaned frequently.

The spade (grate handle), drip pan, and cooking grid are all dishwasher safe.

Use the spade (grate handle) to remove the grill grate from the grill.

For further information refer to the gas grill user guide or contact Customer Service.

## **SECTION 10: APPLIANCES**

**Notes:**



**HDTV ANTENNA/SATELLITE SYSTEM(S)**

**HDTV Antenna (if so equipped)**

Your recreation vehicle is equipped with an exterior fixed height high definition TV antenna. This antenna rotates 360° and is capable of receiving any over-the-air (OTA) high definition television signals being broadcast in your receiving area.

The enclosure base for the antenna (inside the RV on the ceiling) will have a knob that can rotate a full 360° to adjust for the best signal coming to the antenna. Your RV may have one of two types of antenna bases mounted to the ceiling.

The first type has a button on the large knob that must be pressed first to unlock it, so it can be turned. The button may have to be held while rotating, and then once released, locks the antenna in position (arrow on the knob indicates antenna direction).

The second type of antenna base has a large knob that must be pushed upward to unlock the antenna. The knob can then be rotated 360° and when released locks the antenna in place. This antenna has a travel position when you are ready to move your RV. Rotate the handle clockwise (indicated by the arrow on the ceiling plate) until the antenna hits a hard stop and will not rotate further. Turn off the antenna power supply.



**Base with locking button**



**Push knob in to rotate antenna**

**NOTE:** A channel scan must be run to search for and tune in local TV channels. This feature is built into each TV and is not the same as pressing the channel up/down button on the TV remote control. Your TV manual will explain how to perform a channel scan.

**NOTE:** The antenna is a fixed height (12" maximum) and cannot be lowered or raised. Trees and foliage will interfere with receiving a strong HDTV signal.

Refer to the HDTV manufacturer's manual for detailed operating and safety information.

**Antenna Power Supply (if so equipped)**

For good station reception, the antenna power supply must be turned ON to view local television stations. Turning the antenna power supply ON sends 12-volt DC through the cable to the TV roof antenna turning the antenna amplifier ON. Over-the-air HDTV signals are then fed to the TV from the antenna.

Turn the antenna power supply OFF to view cable television or to use the DVD player. The ON/OFF switch is located on the wall plate for the antenna connection. An LED will light to indicate antenna power is ON.



**Antenna Power Supply**

**Satellite (if so equipped)**

Please refer to the manufacturer's instructions for setup, care and maintenance.

## **SECTION 11: ELECTRONICS**

**Notes:**

## **CLEANING THE INTERIOR**

To keep the value of your recreation vehicle, perform regular maintenance using the proper materials and procedures. Using the wrong cleaner may result in damage to the surfaces in your vehicle. Check with the manufacturer's information for the recommended cleaning agent. If in doubt, check to see if the cleaner will cause damage by testing a small area out of sight or contact your dealer for assistance. Do not use flammable liquids or sprays to clean the recreation vehicle.

**Décor Glass (if so equipped):** Use a glass cleaner to remove smudges, smears and spots. If there is decorative etching on the décor glass, use care when cleaning around that area.

**Furniture Upholstery:** To retain the value of your recreation vehicle, maintain the furniture upholstery carefully and keep the interior clean. Vacuum the furniture regularly using a soft brush attachment to remove any loose dirt or debris.

### **Fabric (if so equipped)**

It is recommended the fabric be professionally cleaned if it becomes stained or soiled. The professional cleaner should be made aware the fabrics that may have been treated to be fire resistant. For more information, refer to the specific furniture manufacturer's care instructions.

**Ultraleather™ (if so equipped):** It is recommended the Ultraleather™ be professionally cleaned if it becomes stained or soiled. For more information, refer to the specific furniture manufacturer's care instructions.

**Leather (if so equipped):** Periodic vacuuming, using a dry cloth to wipe up spills immediately, and using a damp cloth on problem areas, will help to keep your leather furniture in good condition. Leather surfaces can vary, as do the cleaning methods. Refer to the furniture manufacturer's recommendation, or consult a cleaning professional.

It is recommended you do not use any cleaners containing oils, waxes or silicones. Cleaners containing silicone can eventually destroy the finish on the leather. Cleaners containing oils or waxes should not be used as they leave residues on the surface of the leather which can attract more dirt which can eventually lead to cracking.

### **Window Treatments**

**Fabric – Drapes and valances:** Dust occasionally with a vacuum and soft brush attachment. It is recommended the fabric be professionally cleaned if it becomes stained or soiled. The professional cleaner should be made aware the fabrics that may have been treated to be fire resistant.

### **Window Shades**

Shades should be vacuumed periodically to remove dust. It doesn't matter what type of shade or fabric you have, using your vacuum cleaners upholstery brush on low suction will remove most dust and dirt from the shade. Refer to the shade manufacturer's owner's manual for additional and detailed information.

To remove stuck on dust or stains refer to the following guide.

**Solar Shields:** Use a sponge or soft brush and water to remove stains. A mild cleaning solution can be used to remove tougher stains. Rinse after cleaning by wetting a clean cloth in fresh water, wringing out any excess and wiping the areas where the cleaner was used.

**Day/Night Shades:** Clean with a mild cleaning solution using a sponge or paper towel. Wipe down with water after cleaning and dry thoroughly before raising the shade. Do not use spot remover, household cleaners or detergents to remove soiled spots, as these may cause damage to fabric or loss of color from fading.

## **SECTION 12: INTERIOR**

**Mini Blinds:** A simple dry rag may do the trick. If they are especially dirty, you can use cold or warm water to clean them; never use hot water.

Fill a spray bottle with water and a tiny amount of soap. Then spray a lint-free towel with the mixture and use the towel to wipe down each slat. While cleaning, try not to bend the slats. They can also be soaked in a bathtub to loosen up any debris so the slats can be wiped down easily.

**Roller Shades:** Can be easily cared for by simply using soapy water or a mild cleaning solution on spots. However, try a small area first. Harsh household cleaners or detergents may cause damage to fabric or loss of color. It is our recommendation to dust the rails and fabrics of the shades on a regular basis. Shades should be kept in the closed or up position when not in use, to maintain pleat retention and minimize dirt and soil build-up. Do not store shades in the down position. This may cause some loss of pleat retention if the shades are not operated on a consistent basis.



**NOTE:** If your recreation vehicle must be stored for an extended period of time, store shades in the up position and cover your windows with additional protection (I.E. Cut out cardboard).

### **Cabinetry and Tables**

To keep hardwood doors, cabinet fronts and hardwood tables looking like new regularly dust with a soft cloth dampened with a cleaning polish or mild detergent solution. Avoid using ammonia based products or silicone oils as they may cause damage if used over a long period of time.

The finish is durable and resistant to most household spills. However, spills should be wiped up promptly to avoid potential problems. Excessive prolonged exposure to direct sunlight, high temperatures and high humidity can cause damage to both the finish and the wood itself. These should be avoided.

### **Interior Wall Panel**

Please contact your dealership service department for assistance in repairing décor paneling. If deep scratches occur on the wall panel, putty sticks can be used to cover scratches on wood surfaces. These can be obtained from local hardwood stores and lumberyards.

To clean, use a mild solution of soap and lukewarm water with a soft sponge or cloth. Wipe dry with a soft, clean cloth.



## **CAUTION**

Do not use abrasive cleaners as they may cause the vinyl to scratch and become dull. Do not use cleaners that contain bleach

### **Quik Panel Wall Panels (if so equipped)**

Quik Panels are used on certain Entegra motorhome models and may be treated and cleaned as a high quality painted surface. All Quik Panels are sealed or glazed and can be cleaned with a soft cloth and mild soap and water (such as dish soap).



**NOTE:** Oil based soaps and cleaners are not recommended. No abrasive cleaners or alcohol cleansers should be used. If other cleaner solutions are used, we recommend trying a spot in an inconspicuous area.

**ABS Plastics**

Dust and wipe clean with soft, damp cloth or chamois, wiping gently. Do not use gritty or abrasive particle soaps or scouring compound to clean ABS plastic. Avoid using “citrus” or biodegradable cleaners that contain “D-Limonene” as they may damage plastic materials.

**SOFA AND DINETTE**

---

Your recreation vehicle may be equipped with one of the following sofa styles.

**Hide-A-Bed Sofa or Sofa Sleeper**

The hide-a-bed sofa functions much the same as a regular residential hide-a-bed sofa. To make the hide-a-bed sofa into a bed, remove the seat cushions and pull the sofa back towards you firmly and gently. Activate (or deflate) the air mattress (if so equipped) using the supplied furniture manufacturer’s instructions. To convert the hide-a-bed back into the upright sofa position, reverse the process.

**Jack Knife Sofa**

The Jack Knife sofa functions much the same as a residential futon. To make the sofa in to a bed, lift up on the bottom seat cushion and pull it towards you. The sofa back will drop down to provide a sleeping surface. For additional comfort and to reduce fabric damage, you may want to place a cover or air mattress (customer supplied) over the sofa when it is in the sleeping position.

**Trifold Sofa**

The Trifold Sofa offers very similar features to the traditional hide-a-bed. The following illustrations detail converting the sofa into a bed.

1. Remove the tri-fold sofa pillows and set aside.
2. Using the strap handle, pull the sleeping surface up, then out.
3. While sleeping surface is up, fold out legs. Extend the sleeping surface until grounded.
4. Once sleeping surface is grounded, fold head board down flat.

## SECTION 12: INTERIOR



### Cube Sofa

The Cube Sofa functions similar to a residential futon. The slanted back pillows offer numerous options as a sofa, along with the ability to extend the cushions for additional sleeping space.

### Booth Dinette (if so equipped)

The dinette is designed to seat up to four adults. Depending on your model, there may be a storage area in the dinette bench. To access this storage, remove all the cushions and lift up on the bottom seat support. **If the bottom seat support is secured closed with screws, do not remove the seat support or use this area for storage.**

The dinette seats that are secured with screws contain factory installed equipment and should only be accessed by a qualified service technician.

### Converting the dinette to the bed position

Remove all the cushions from the booth dinette. Lift up the tabletop and remove the detachable table legs. Place the tabletop on the ledges provided between the booth dinette benches. Lay the seat back cushions against the back of the dinette bench. Lay the dinette seat bottom cushions in between the seat back cushions. The area where the cushions meet should be slightly raised. Push the raised cushion ends down gently as the cushions are designed to fit snugly. Reverse this process when converting back to the booth dinette.

### Free-Standing Table and Chairs (if so equipped)

The free-standing dinette table can be positioned to seat up to four people. To prevent damage, the free-standing dinette chairs should be fastened securely at the dinette table when you are traveling

**PANTRY OR HUTCH (IF SO EQUIPPED)**

Your recreation vehicle may have a pantry or hutch that you can use for storage. Make sure all items stored in the pantry or hutch are secured to prevent shifting during travel. This cabinetry has been designed to accommodate the normal camping items which may be bulky but not necessarily heavy. **Remember your recreation vehicle's load capacity is designed by weight, not volume, so you cannot necessarily use all available space.**

If your pantry or hutch has sliding pantry shelves, they have been equipped with a locking mechanism to keep them in place during transit. To secure the shelf in place, push it all of the way in until the latch tab clicks into place. Always pull out slightly on the shelf to make sure that it is stationary and secure in the transit position. To release the shelf, push in on the tab and pull the shelf slowly towards you.

**⚠ WARNING**

Your RV's load capacity is designated by weight, not by volume, so you cannot necessarily use all available space when loading the vehicle. Do not exceed your GVWR and ensure you are loading the vehicle as evenly as you can for the best possible handling. Ensure heavy items are secured so they do not shift during travel.

**COUNTERTOPS**

**To prevent permanent damage**

- Always use hot pads or trivets under hot pans, dishes, or heat producing appliances such as frying pans. Heat will damage the countertop.
- Use a cutting board to prevent unnecessary damage to the countertops. Do not cut directly on the solid surface countertop.
- Avoid harsh chemicals such as drain cleaners, oven cleaners, etc.
- Do not let cleaners with bleach set on the top. Wipe them off promptly.

For additional information on the removal of difficult stains or surface damage repair, refer to the countertop manufacturer's user guide.

Your recreation vehicle may be equipped with one or both of the following countertops.

**Laminate Countertops (if so equipped)**

Glass rings, food spills, water spots and smudges usually wipe off with a damp sponge. Stubborn stains can be removed with a general-purpose spray cleaner. Some stains can be removed by squeezing fresh lemon juice over the stain and allowing the juice to soak for approximately forty-five minutes. After 45 minutes, sprinkle baking soda over the lemon juice and rub with a soft cloth.

**Solid Surface Countertops (if so equipped)**

Soapy water, ammonia based cleaners (not window cleaners as they can leave a waxy build up that may dull the surface) or commercially available solid surface cleaners will remove most dirt and residue from all types of finishes. A damp cloth followed by a dry towel will remove watermarks.

Difficult stains can be removed from the matte finish with a green Scotch Brite® pad and a mild abrasive cleaner. Disinfect the surface periodically with diluted household bleach (one part water to one part bleach).

For cuts and scratches, sand the matte finish lightly with (220) fine grit sandpaper until the cut or scratch is gone. Restore finish with a green Scotch Brite® pad and mild abrasive cleaner.

## **SECTION 12: INTERIOR**

Run cold water when pouring hot/boiling water into the sink.

### **Solid surface sink maintenance**

Occasionally, clean the solid surface sink by filling one-quarter full with a 50/50 water/bleach solution. Let soak for 15 minutes, and then wash sides and bottom of sink as solution drains.

## **FLOORING**

---

Always test a cleaning agent in an inconspicuous area for colorfastness.

### **Carpet**

Vacuum your carpet regularly. It is important to remove loose soil and debris while it is on the surface. Heavily traveled areas (i.e., walkways, areas in front of the furniture) may be protected with small throw rugs to prolong the life of the carpet.

Prompt attention to spots and spills is essential. Remove as much of the spill as possible. Absorb wet spills as quickly as possible by blotting repeatedly with white paper or cloth towels.

Refer to the manufacturer's guide for detailed cleaning information, or contact a cleaning professional.

### **Vinyl Flooring**

Periodically vacuum or sweep to remove dirt and gritty particles. Although most common spills will not permanently stain the vinyl floors, they are usually easier to remove if wiped up before they set. Blot with a paper towel and wipe clean with a damp cloth. Do not use dish detergents or vinegar and water because they will dull your floor.

To care for the vinyl floor covering, use a damp mop with water and a mild cleaner on the entire floor. **DO NOT SOAK THE FLOORING.** Use care to avoid wetting the carpet edges. To avoid problems of "yellowing" linoleum, the flooring manufacturer recommends avoiding cleaners that contain oil based solvents (i.e. lemon oil, Murphy's Oil Soap, etc.).

## **MURPHY BED (IF SO EQUIPPED)**

---

Your recreational vehicle may be equipped with a folding Murphy bed. When in the closed position, the bed is stored in the wall allowing for more living space within the vehicle. When you want to use the bed, the sofa folds flat and the bed can be pulled down over the sofa into the sleeping position.



**Stored Position**



**Sleeping Position**



## ⚠ CAUTION

The slide out **must be fully extended** before putting the Murphy bed in the sleeping position. The Murphy bed **must be in the stored position** before the slide out can be moved to the in (travel) position. Failure to do so may result in injury or property damage.

This label has been installed in your recreational vehicle at the foot end of the Murphy bed. **It should not be removed.**

### Unfolding The Sofa

With the slideout fully extended, unfold the sofa into the flat position.

- ❑ Standing at the side of the sofa, grasp the front of the seat cushion and the top of the back cushion (A) (arrows).
- ❑ Lift up on the seat cushion while pulling the top of the back cushion in toward the seat. The seat and back will form a “V” shape. (B).
- ❑ Pull the seat cushion out away from the front of the sofa into the flat position (C).



### Lowering The Murphy Bed

- ❑ Unlatch the “D” bolt latches on each side of the bed at the footboard (in the stored position). This will release the Murphy bed allowing it to unfold.
- ❑ Firmly grasp the handle on the footboard of the Murphy bed, and pull it towards you.
- ❑ The bed will begin to unfold. Pull it all the way down so the footboard rests on the floor.
- ❑ When the bed is in the sleeping position, locate the web straps with snap hooks on the footboard of the bed (there is one on each side of the bed). Attach (both) snap hooks to the metal loops located on the sofa arms. **These straps and loops keep the bed from folding up while in use.**



**NOTE:** The straps are adjustable. They have been installed at a length that holds the bed securely in place and allows ease of attaching the snap to the metal loops.

### NOTICE

The murphy bed must be folded up and secured in place before moving the slideout to the in position.

Moving the slideout before the bed is properly stored and secured may result in damage to the bed and /or slideout.

## **⚠ WARNING**

**Snap hooks (if present) must be attached to the steel rings on the sofa arms before using the bed.** Failure to attach these snap hooks to the steel loops on the sofa can result in serious injury or property damage.

**MAKE SURE THE SAFETY STRAPS AT EACH SIDE OF THE FOOTBOARD ARE ATTACHED TO THE STEEL LOOPS ON THE SOFA ARMS BEFORE PUTTING ANY WEIGHT ON THE BED.**

The label shown here is located next to the slide out controls inside the entrance door. **It should not be removed.**

**⚠ CAUTION**

This Murphy Bed is equipped with two hold-down methods for use when the bed is lowered in the sleeping position.

1. An automatic latching system and
2. Manual safety straps

Be sure both of these methods are used and completely engaged to prevent the bed from lifting or folding up unexpectedly which may result in personal injury.

Consult your owner's manual and/or your authorized independent dealer for additional information. 000414

**NOTE:** On some models, the Murphy bed may lock in place when lowered to keep it from flipping up unexpectedly. In order to release the bed, a lever must be pulled first. There are two types of levers. One is a "T" handle installed in the side dresser and the other is a lever built into the side of the couch. When the lever is pulled, the bed can be returned to the folded or stored position. Make sure to latch the sliding "D" bolts on each side when bed is returned to the upright stored position.

Remove the straps holding the mattress to the bed frame by unsnapping the two plastic buckles on top of the mattress. These straps can be stored on the side of the mattress, or tucked between the headboard and the mattress. Release the mattress hook from the foot of the bed.

### **Storing The Murphy Bed**

- Attach the "Y" strap that holds the mattress to the bed-frame. Pull the straps with the buckles up from the head of the bed and snap them to the "Y" strap. Secure the snap hook at the footboard. **MAKE SURE THE SAFETY STRAPS AT EACH SIDE OF THE FOOTBOARD ARE STILL ATTACHED TO THE STEEL LOOPS ON THE SOFA ARMS BEFORE PUTTING ANY WEIGHT ON THE BED.**
- Unhook the safety strap snap hooks from the steel loops on the arms of the sofa.
- Release the locking lever (if applicable) so bed can be raised.
- Push the bed back up into the storage position.



## ⚠ WARNING

Keep hands and fingers away from the collapsing footboard and struts when pushing the bed back in to the storage position.

- Secure the two “D” bolts on each side of the bed.
- Flip the sofa back up into the seated position:
  - Firmly grasp the edge of the top cushion and the front edge of the seat cushion.
  - Push the cushions down and towards each other so they form a “V” shape.
  - While holding the cushions in this “V” shape, rotate the sofa back towards the wall and the cushions will revert to the seated position.

### **BED STORAGE**

Additional storage has been provided under the bed. To access the storage area, grasp the end ledge at the foot of the bed and lift carefully. ***The bed platform must be held when raised.***

***It is recommended that two people retrieve stored items from under the bed*** so that one person may hold the platform, and the other to retrieve the stored items from under the bed. Lower the platform slowly to close it. **DO NOT DROP THE PLATFORM.**

Certain models may be equipped with a ***prop rod or gas struts*** to assist with easy access to under bed storage.

#### **Prop Rod (if so equipped)**

If your model is equipped with a prop rod:

- With the help of a second person, raise the bed platform.
- Release the prop rod from its holder.
- Put the end of the rod in the bracket under the bed platform.
- To lower the platform, release the prop rod from the bracket under the bed platform, re-attach the prop rod to the holder on the bed base.
- Lower the platform slowly until closed.

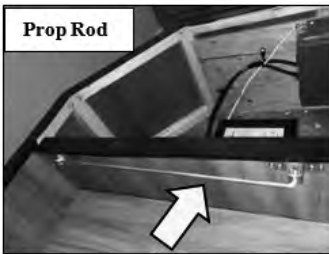

### **⚠ WARNING**

- ❑ Before lifting, be sure there is nothing on the bed that will restrict its movement or add extra weight.
- ❑ **Use caution when opening or closing the bed to keep hands and fingers at the end ledge provided (not on the side or farther back than necessary).**
- ❑ Exercise extreme caution when opening the bed storage platform. Platform must be held open (unless equipped with a prop rod or gas struts) and slowly lowered until closed.
- ❑ The bedroom electric slide room system may be located under the bed. Use care not to obstruct the slide room system when using the under bed storage.
- ❑ **Failure to comply with these guidelines can result in serious injury or property damage.**

#### **Gas Struts (if so equipped)**

On certain models, the bed platform may be equipped with gas struts to assist with easy access to storage area.

- ❑ Grasp the end ledge at the foot of the bed and lift carefully.
- ❑ Two gas struts will hold the bed platform open allowing access to the storage area.
- ❑ To close, carefully push down on the bed, slowly easing it to the closed position.
- ❑ Follow all precautions listed above when opening/closing the platform.

#### **LOFT SLEEPING AREA (IF SO EQUIPPED)**

Your RV may be equipped with a loft sleeping area. Access to the loft sleeping area is through the use of a (wood or steel) ladder.

The steel ladder is equipped with hooks that fit over the side board of the loft bed.

Typically the wood ladder is attached to a closet door (or wall) and pivots out for use (A & B). Be sure the door is closed and latched, and the ladder is securely in place before climbing up to the loft area. When storing the ladder, make sure to buckle the security strap which keeps the ladder in place in its holder.



**Loft Sleeping Area**

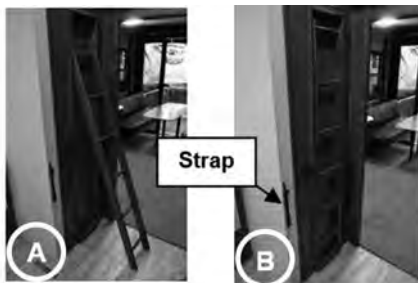

**Ladder access to sleeping loft**



**NOTE:** Loft area appearance and design may differ by model.

**BUNK BEDS (IF SO EQUIPPED)**

Your recreational vehicle may be equipped with bunk style beds. Bunk bed weight ratings will vary depending on the style of bunk bed. Refer to the warnings for bunk beds below.

**BUNK BED LADDER (IF SO EQUIPPED)**

Your recreational vehicle may be equipped with a ladder to access the upper bunk. This ladder may be a separate steel ladder, or a wooden ladder attached to the bunk beds.

The top of the ladder is secured to the ladder storage compartment. To operate the ladder, lift up and out of the storage tray. Pivot the bottom of the ladder out. Be sure the ladder is securely in place before climbing to the upper bunk.

When storing the wood ladder, place the bottom of the ladder back into the tray in the storage compartment. This keeps it secure during transport and clear of walkways. The steel ladder (if equipped) would simply hook onto the upper bunk



**NOTE:** Some types of bunk beds will not include a ladder.

## **⚠ WARNING**

- Exercise extreme care when entering or exiting the bunk beds and using the ladder (if so equipped).
- Do not allow more than one person on the top bunk.
- Do not allow children under 6 years of age to use the upper bunk.
- Do not allow horseplay on or under the bed and prohibit jumping on the bed.
- Make sure the ladder (if equipped) is anchored properly to the bed.
- Never allow more than one person on the ladder (if equipped) at a time.
- Children should always be supervised when using the ladder (if equipped) or when entering or exiting the bunk beds.
- Weight limit of the bunk ladder (if equipped) is 300 lbs. (136 kg).
- Maximum weight limits for bunk beds
- Bunk bed styles vary according to RV model.
- Maximum weight ratings vary according to bunk bed style.
- Weight rating labels are located at all bunk locations:

**Typical  
Bunk Bed  
Maximum  
weight  
rating label**

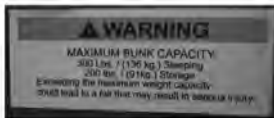

- Do not exceed the weight limits of the bunk bed or the bunk ladder (if equipped).
- Failure to follow these instructions can result in serious bodily injury.

**CLEANING THE EXTERIOR**

To protect your recreation vehicle's exterior finish, wash it often and thoroughly.

For recreation vehicles with painted exterior graphics: If desired you may wash and wax your vehicle 60 days after purchase. The exterior paint does need time to cure before any wax is applied to the exterior surface. Careful maintenance for the first 60 days will assure a long lasting durable finish.

Your recreation vehicle is exposed to many environmental conditions that have an adverse affect on the paint finish:

- Road Salt and Sodium Chloride
- Road Tar / Bugs
- Bird Droppings / Tree Sap
- Industrial Fallout / Acid Rain /Pollution
- UV Exposure and Moisture

The most common problems resulting from these conditions are corrosion, staining, and chemical spotting. Generally, the longer the foreign material remains in contact with the exterior finish, the more extensive the damage. These problems can be minimized by regularly scheduled washing and polishing. Wash your recreation vehicle as soon as possible if it becomes contaminated with foreign material.

Avoid parking under trees or near ocean sea salt. Ice or snow should not be scraped from the painted surface: Brush off!

Gravel roads should be avoided.

Anti-freeze, gasoline or washer solvents if spilled on the painted surface should be rinsed off with water immediately. Bugs and bird droppings should be rinsed off daily.

**Washing**

Commercial washing should be avoided. Wash with cold water using a mild liquid soap. Dry wiping with a dry cloth is not recommended.

Make sure the RV's surface temperature is cool, under 90 F, and out of direct sunlight. A shaded area is ideal for washing your vehicle as direct sunlight causes water spotting. Use a mild soap, detergent or car wash shampoo. Try to avoid combination wash-n-wax products as these waxes can cause build up and are designed for smaller surfaces. Have two dedicated sponges or wash mitts: one for the exterior walls and one for the wheels and under carriage. Brushes or wash mitts made of plastic bristles are acceptable for use on tires and wheel wells, but are not intended for use on the exterior walls. Avoid using such items on painted surfaces as they will damage the finish. Wash the wheels and wheel wells first as this removes heavy dirt and debris and prevents it from splattering on panels. Wet the entire area down to remove loose dirt and grime, then hand wash one area at a time using your dedicated paint finish sponge or wash mitt. Wash from the top and work your way down, rinsing frequently to minimize grit abrasion. Follow with a final rinse of water. This process will remove most contamination from the recreation vehicle's surface.

For stubborn stains such as road tar or bug stains, use an ammonia based glass cleaner or a small amount of rubbing alcohol on a damp cloth followed immediately by warm soapy water, and rinsing with clean water. This may not dissolve the road tar, but it will loosen tar and bug stains and remove them from the surface.

Do not use solvent based cleaners on bird droppings or tree sap as these are water based stains. They can be dissolved using ammonia based glass cleaner, warm soapy water and a little "elbow grease". Once again, after removing stubborn stains immediately rinse with clean water.

## SECTION 13: EXTERIOR

Drying the recreation vehicle is just as important as washing your vehicle. Tap and well water contain many chemicals that could water stain your vehicle's finish.

We suggest using a damp natural or synthetic chamois. There are other drying products such as lint-free micro-fiber towels that work just as well.

### **During cold weather**

Salt and other chemicals that are spread on winter roads in some geographical areas can have a detrimental effect on the recreation vehicle's underbody. **If your recreation vehicle is exposed to these conditions, spray the underbody with a high-pressure hose every time you wash the exterior of your recreation vehicle.**

Take special care to remove mud or other debris that could trap and hold salt or moisture. After washing your recreation vehicle, wipe off all water drops from the rubber parts around the slideout and doors.



**NOTE:** When the slideout or door is frozen, opening it by force may tear off or crack the rubber gasket that is installed around the slideout or door. Therefore, pour warm water on the gasket to melt the ice (wipe off the water thoroughly after opening the slideout or door). To prevent the weather stripping from freezing, treat it with a silicone spray.

### **Waxing**

Wax your recreation vehicle once or twice a year, or when painted surfaces do not shed water well. Use a soft cloth to apply a small amount of wax to the painted surfaces. After the wax has dried, polish the recreation vehicle with a dry, soft cloth.

Do not wax your recreation vehicle in direct sunlight. Wax it after the surfaces have cooled.

Do not apply wax to any area having a flat black finish as it can cause discoloration. If the finish has been stained with wax, wipe off the area with a soft cloth and warm water. When waxing the area around the various openings, do not apply any wax on the weather strip. If it is stained with wax, the weather strip cannot maintain a weatherproof seal around the opening.



## **CAUTION**

- Do not use waxes containing high-abrasive compounds. Such waxes remove rust and stains effectively from the paint work, but they are also harmful to the luster of the painted surface since they scrape off the coating. Further, they are detrimental to glossy surfaces, such as the grille, garnish, moldings, etc. do not use gasoline or paint thinners to remove road tar or other contamination to the painted surface.
- Do not use a buffer and a buffing compound as it may damage the exterior surface. Please contact a professional paint body shop for assistance.



### **Polishing your recreation vehicle**

If painted surfaces have been severely damaged and have lost their original luster and color tone, polish the surface lightly with a fine polishing compound. Avoid limiting your polishing to the damaged surface only; polish a somewhat wider area, moving the polishing cloth in one direction. After polishing, flush the compound from the surface and apply a coat of wax to regain a beautiful luster.

### **Damaged paint**

To prevent corrosion, touch up small cracks and scratches in the paint coat as soon as possible with touch-up film or paint. Carefully check the body areas facing the road and the tires for damage to the paint coat caused by flying stones, etc. Use the closest automotive paint (available locally) match possible when touch-up paint is needed.

### **Cleaning plastic parts**

Use a sponge or chamois to clean plastic parts. Use warm water and a soft cloth or chamois to remove any white residue from dark colored plastic surfaces. Do not use a scrubbing brush, other hard tools, or wax containing abrasives as they may damage the plastic surface.

### **Chrome parts**

To prevent chrome parts from spotting or corroding, wash with water, dry thoroughly, and apply a non-abrasive automotive wax. If the chrome is severely damaged or pitted, use a commercially available chrome polish product.

## **CAUTION**

Do not allow plastic to come into contact with brake fluid, engine oil, grease, paint thinner, or battery acid. These will damage plastic. Use a soft cloth and a mild detergent solution to wipe away any such contact.

### **FRAME**

Sand, pebbles, objects on the highway, climate (salt air exposure) or ice inhibiting chemicals used during the winter months will damage the paint, inviting rust and other deterioration. Periodically inspect the exterior exposed areas, clean and repaint the frame members occasionally and whenever you notice rust or paint chipped away, to insure protection.

### **E-Z LUBE OR SUPER-LUBE AXLE (IF SO EQUIPPED)**

The E-Z lube or Super-lube feature on your axles provides the ability for the bearings to be periodically lubricated without removing the hubs from the axle. This feature consists of axle spindles that have been specially drilled and fitted with grease zerks in their ends. When grease is pumped into the zerk, it is channeled to the inner bearing and then flows back to the outer bearing and eventually back out the grease cap hole. If you have further questions, consult with your dealer.



**NOTE:** The convenient lubrication provisions of the E-Z lube or Super-lube feature must not replace periodic inspection and maintenance of the bearings. Use a hand-operated grease gun; improper use of a commercial grease gun may damage the seals.

## SECTION 13: EXTERIOR

### EXTERIOR ROOF AND SIDEWALL VENTS

Inspect the roof vents (including sealants) for cracks and keep them clean. Inspect the refrigerator and holding tank vents for blockages from bird nests, spider webs, leaves, etc. All exterior access doors and vents need to be kept clean and free of obstructions (i.e., insect nests, mud daubers, etc.) while the appliances are in use.

### WINDOWS

Any ventilating window may permit water inside, especially during heavy rainstorms. Condensation will also cause water to accumulate on windows and in the tracks.

The window “glass” can normally be cleaned with a sponge and water. Use glass cleaner to remove wax, oil, grease, dead insects, etc. After washing the glass, wipe it dry with a clean, soft cloth.

### EXTERIOR LADDER (IF SO EQUIPPED)

Your recreation vehicle may be equipped with an exterior roof ladder. The RV roof has decking under the rubber roof membrane to allow you to walk on the roof (with caution) to do maintenance.

#### **⚠ WARNING**

- ❑ If your recreation vehicle is equipped with a roof ladder, do not leave items attached to it while traveling. **DO NOT** exceed the weight rating of the ladder (ladder weight capacity label is located under the bottom step of the ladder). There should never be more than one person on the ladder at the same time.
- ❑ **Self-Storing ladders:** Make sure to pull all (there may be up to 4) pins to unlock the ladder. All pins **must be re-inserted** when locking the ladder open for use. Failure to do so may result in serious personal injury.

Some models may be equipped with a self-storing ladder mounted to the side of the vehicle.

#### **Self-Storing Ladder operation**

1. Pull all the locking pins (arrows) out of the ladder brackets (**Fig. A**).
2. Pull the ladder down and toward you and it will swing away from the RV.
3. When the brackets are extended (**Fig. B**), re-insert the pins (arrows) to lock the ladder in place while in use.
4. To return the ladder to the storage position; pull the locking pins and push the ladder up and in towards the RV.
5. When the ladder is in the storage position, re-insert all locking pins to prevent the ladder from opening while traveling.

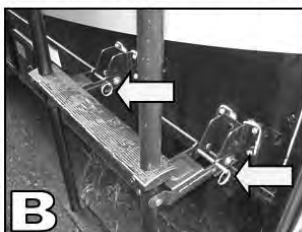
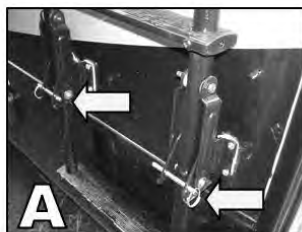

**⚠ WARNING**

**LADDER CAPACITY MAXIMUM  
300 LBS (136 KG)**

- DO NOT exceed the ladder maximum weight rating.
- The maximum rating includes the person's weight PLUS weight of items carried.
- When climbing:
  - Always face the ladder.
  - Climb slowly with weight centered between side rails.
  - Keep a 3 point contact on the ladder at all times.
  - 3 Point contact - two hands and a foot or two feet and one hand.
- Keep hands free.
  - Use of accessories such as lanyards to keep carried items tethered will keep hands free and prevent falling items.
  - Heavy or bulky items should be brought up only after reaching the roof.
- Do not use the ladder if damaged in any way.

**Failure to follow these instructions can lead to ladder collapse, a fall, or dropped items which could result in death or serious injury.**

**SEALANTS**

**⚠ CAUTION**

Failure to properly maintain or reseal your recreation vehicle may result in serious water damage to the roof and other parts of the recreation vehicle. This damage is not covered by the **Towable Limited Warranty**.

Sealants perform a very important function and should be inspected closely and regularly maintained. We incorporate many different types of sealants, including butyl/putty, black butyl-encapsulated foam, silicone (clear and colored), roof sealant and foam. In general, sealants do not have "set" lifetimes. Varying environmental factors affect the pliability and adhesiveness of sealants.

You or your dealer must:

- Inspect all sealants, a minimum of every six months. Make sure to check the roof and all four sides of the recreation vehicle including al moldings, doors, vents and exterior attachments. A quick walk around the recreation vehicle before leaving may help prevent potential problems during trips and vacations.
- Have the sealant replaced if you notice any cracks, peeling, voids, gaps, breaks, looseness or any sign of physical deterioration. Reseal at least one time each year as preventative maintenance.
- Always use the same type of sealant that was removed. Your dealer recreation vehicle service or parts manager can help you obtain the correct sealant(s).

The sealants may become damaged due to road vibration, ultraviolet exposure, air pollution, freezing temperatures and exposure to other elements. If deteriorated, repair immediately to prevent damage.

## **SECTION 13: EXTERIOR**

If you notice water inside the recreation vehicle, immediately have the dealer check for the source of the leak. Failure to correct the leak may result in serious damage to your recreation vehicle; this damage may not be warrantable.

Although the following diagrams may not accurately reflect the exact model of your recreation vehicle, make sure you inspect all sealants as indicated in the text. If you have questions and/or need assistance with sealing your recreation vehicle, consult with your recreation vehicle dealer.

### ***FIFTH WHEELS - SEALANT DIAGRAM***

---

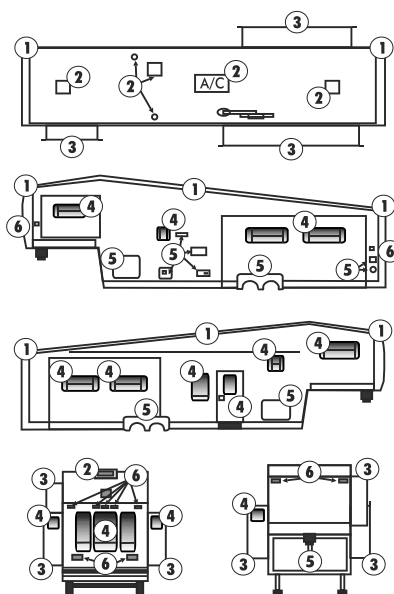

- 1. Trim Edges**
- 2. Roof items**
- 3. Slideout Roof/Floor**
- 4. Windows/Doors**
- 5. Storage Compartments/  
Access Doors/Wheel Wells**
- 6. Lights**

### **TRAVEL CHECKLIST**

Following is a preliminary list of items that need to be checked before leaving your home or campsite. This is a general list, which you may want to customize as you determine your own needs.

#### **Safety**

- Make sure you follow all safety precautions noted in this owner's manual and in any manufacturer's operators manual when preparing to travel.

#### **Maintenance**

- Inspect seals and reseal as needed.
- Have the propane system checked for leaks by your dealer.
- Check wheel lug nuts after first two hundred miles and at specified intervals to listed torque specifications, re-torque as needed.
- Have brakes adjusted by a qualified service technician.
- Sanitize the fresh water system.
- Test the safety alarms.

#### **Before leaving home (or campsite)**

- Make sure all tow vehicle fluids are at proper levels. Check the engine oil, transmission fluid, engine coolant, power steering fluid and wind shield washer fluid.
- Check the lights on the RV. Have someone observe the operation of all exterior lights while you activate the controls. Check the turn signals and brake lights.**
- Examine the tires for excessive tread wear or uneven wear patterns. Check for stones, nails, glass or other objects lodged in the tread. Inspect for tread cuts or sidewall **cracks**.
- Check tire pressure** (including spare) and correct according to manufacturer specifications.
- Check wheel lug nuts for tightness.**
- Inspect safety chains for signs of wear.**
- Inspect and work all interior and exterior latches and locks (lube if necessary).
- Make sure the batteries are fully charged and installed correctly.
- Inspect the power cord and carefully clean the contacts if necessary. Plug in the power cord to an appropriate power source.
- Turn on the interior lights and check outlets for polarity. If needed, replace any blown fuses. Check the circuit breakers and test the GFCI.
- Check the propane cylinder gauge to make sure there is propane available. Make sure the propane cylinder is in place and secure for transport.
- Inspect and turn on the propane system.** If you have any questions, contact your dealer or a qualified propane service representative for assistance. If the propane system is functioning properly, test any pilot lights or direct spark ignition features.
- Inspect and test all safety detectors.** If needed, replace any drained or discharged batteries. If you have a defective or damaged safety detector, replace it immediately.
- Inspect the leveling jacks (if so equipped) for operation. If needed, perform maintenance as specified by the leveling jack manufacturer.
- Test all exterior and interior lights. Replace any bulbs if they are burnt out.
- Wash the exterior of the RV. Do a sealant inspection and repair as necessary.
- De-winterize and **sanitize** the fresh water system.
- Connect your tow vehicle to the RV and test all connections and lights. Test brakes.**

## **SECTION 14: TRAVEL/CAMPING/STORAGE CHECKLISTS**

### **Before leaving the campsite**

- Check the area under the RV after overnight parking and look for water or other fluid leaks. If leaks are detected, find the cause and correct it immediately.
- Turn off propane tanks.
- Empty black and gray holding tanks, rinse as needed (if so equipped).
- Retract awning and secure in place for transport (if so equipped).
- Close roof vents.
- Close windows & latch blinds.
- Disconnect any cable TV or phone hookup, and lower the TV antenna (if so equipped).
- Turn off interior lights.
- Turn off water heater, water pump, furnace and appliances.
- Snap the Range Hood vent closed (if so equipped).
- Latch drawers, cabinets & doors. Counter items put away or tied down.
- Fasten and secure the furniture for travel (if so equipped).
- Refrigerator door locked (if so equipped). Set to 12-volt (if applicable).
- Secure any loose, heavy or sharp objects in the RV or exterior compartments.
- Disconnect the power cord and ensure it is stored correctly.
- Disconnect any water connections.
- Fasten all interior and exterior doors securely. Lock them (if so equipped).
- Move slideout(s) in and lock it in place (if so equipped).
- Walk around your RV one last time to make sure everything is stored away and the baggage compartments are closed and locked.
- Retract leveling jacks to the travel position (if so equipped).
- Retract step.
- Secure and lock the entrance door.

### **RV STORAGE**

Properly preparing your RV for storage during periods of non-usage will prevent problems from arising. It will also make it easier to get started again for the following camping trip or season. To prevent costly freeze-ups, winterize the plumbing system when it will not be in use for an extended period of time, especially if it is stored in colder climates.

#### **Prior to Storage**

- Store your RV indoors, under a roof or a “breathable” cover for use during storage.
- To prevent weather checking and other UV damage, cover tires exposed to sunlight.
- Thoroughly wash the interior and the exterior of your RV.
- Do not use the stabilizing jacks during storage.
- Check the roof and other surfaces to ensure there is no damage and potential leakage that might otherwise go unnoticed.
- Inspect and seal off any area that offers an entry point for rodents, birds or insects. Cover all external outlets (i.e. furnace, vents etc.). Damage from birds, rodents, insect, etc., is not covered under the “Towable Limited Warranty” applicable to your RV.
- Close all windows and roof vents.
- Cover the roof air conditioner (if so equipped).

## SECTION 14: TRAVEL/CAMPING/STORAGE CHECKLISTS

- Close the propane cylinder valve(s). We recommend using a propane cylinder cover, and to make sure the propane regulator is covered. If is equipped with a gas/electric DSI range, light a range gas burner to consume any gas remaining in the lines. Once the flame extinguishes itself, turn the burner valve OFF.
- Drain all water lines. Make sure the RV is winterized
- Drain and flush all holding tanks (fresh water, gray water, black water and/or hot water tanks).
- Adding fuel stabilizer to the generator (if so equipped) will aid in preventing condensation and fuel varnishing.
- Disconnect 120-volt AC power to the RV.
- Remove all batteries from the RV and store in a place where they will not freeze. A battery that has been frozen will never hold a proper charge.
- Turn all cushions on edge to prevent the moisture/mildew buildup during storage.
- Turn off 12-volt DC/120-volt AC/propane to the refrigerator; defrost and clean. Block the doors open so air can circulate and prevent mildew, or use crumpled newspaper or open boxes of baking soda in the refrigerator to eliminate odors during storage.
- Remove all perishables from the cabinets. Leave the cabinets and doors ajar to allow air circulation and prevent mildew and musty odors.
- Lubricate locks and hinges on exterior doors.

### **During Storage Period**

Remove snow from the top of your RV to prevent damage to the unit's structure.

## **CAUTION**

Excessive snow, 8" or more, or ice, 2" or more, places excessive weight on the RV roof. Remove excessive snow or ice as needed. Care **MUST** be exercised to not damage the roof material when removing snow and ice. Excessive weight can damage the roof, seals, etc. Water leaks and poor fit or operation are the results of this damage.

## **SECTION 14: TRAVEL/CAMPING/STORAGE CHECKLISTS**

**Notes:**



***FEATURED COMPONENTS QUICK REFERENCE CHART***

Your recreation vehicle may be equipped with some of the items listed below. This is a partial listing and it is not intended to cover all components. All information is the latest available at the time of publication. Jayco reserves the right to change any of the following information without notice.

<b>Component</b>	<b>Manufacturer</b>	<b>Website</b>
Air Conditioner	Coleman-Mach	<a href="http://www.airxcel.com/coleman-mach">www.airxcel.com/coleman-mach</a>
Awning	Lippert Components Carefree of Colorado Dometic	<a href="http://www.lci1.com">www.lci1.com</a> <a href="http://www.carefreeofcolorado.com">www.carefreeofcolorado.com</a> <a href="http://www.dometic.com">www.dometic.com</a>
Axle	Lippert Components Dexter Axle	<a href="http://www.lci1.com">www.lci1.com</a> <a href="http://www.dexteraxle.com">www.dexteraxle.com</a>
DVD/CD	See manufacturers' user guide	
Entrance Step	Lippert Components Mor Ryde Step Above	<a href="http://www.lci1.com">www.lci1.com</a> <a href="http://www.morryde.com">www.morryde.com</a>
Fan, Exhaust 12V	Ventline Maxx Fan	<a href="http://www.ventline.com">www.ventline.com</a> <a href="http://www.airxcel.com/maxxair/products/fans">www.airxcel.com/maxxair/products/fans</a>
Fire Extinguisher	See manufacturers' user guide	
Furnace	Atwood/Hydroflame	<a href="http://www.atwoodmobile.com">www.atwoodmobile.com</a>
Microwave	See manufacturers' user guide	
Monitor Panel	KIB Enterprises	<a href="http://www.kib.us">www.kib.us</a>
Outside Shower / Utility Center	B & B Molders	<a href="http://www.bandbmolders.com">www.bandbmolders.com</a>
Propane Tank	Manchester Tank	<a href="http://www.mantank.com">www.mantank.com</a>
Propane/Carbon Monoxide Alarm	See manufacturers' user guide	
Propane Regulator	Dehco	<a href="http://www.dehco.com">www.dehco.com</a>
Range/stove/cooktop	Atwood Suburban Dehco	<a href="http://www.atwoodmobile.com">www.atwoodmobile.com</a> <a href="http://www.airxcel.com/suburban/products/cooking">www.airxcel.com/suburban/products/cooking</a> <a href="http://www.dehco.com">www.dehco.com</a>
Range hood	Ventline Inc.	<a href="http://www.ventline.com">www.ventline.com</a>
Refrigerator	Norcold Frigidaire Samsung Dometic GE	<a href="http://www.norcold.com">www.norcold.com</a> <a href="http://www.frigidaire.com">www.frigidaire.com</a> <a href="http://www.samsung.com">www.samsung.com</a> <a href="http://www.dometic.com">www.dometic.com</a> <a href="http://www.ge.com">www.ge.com</a>
Smoke Alarm	See manufacturers' user guide	
Tank Sprayer/BLK	B & B Molders	<a href="http://www.bandbmolders.com">www.bandbmolders.com</a>

## **SECTION 15: ADDITIONAL INFORMATION**

Thermostat	Coleman Mach	<a href="http://www.airxcel.com/coleman-mach">www.airxcel.com/coleman-mach</a>
Toilet	Thetford Corp.	<a href="http://www.thetford.com">www.thetford.com</a>
TV	See manufacturers' user guide	
TV Antenna	Winegard Company	<a href="http://www.winegard.com">www.winegard.com</a>
	King Jack	<a href="http://www.kingconnect.com">www.kingconnect.com</a>
Water Heater, Tank DSI	Atwood Greenbrier	<a href="http://www.atwoodmobile.com">www.atwoodmobile.com</a>
Water Heater, Tankless	Girard Systems	<a href="http://www.greenrvproducts.com">www.greenrvproducts.com</a>
	Truma AquaGo	<a href="http://www.truma.com">www.truma.com</a>
Water Pump, 12V	Shurflo East	<a href="http://www.shurflo.com">www.shurflo.com</a>



**SECTION 15: ADDITIONAL INFORMATION**

**Jayco  
Ownership Notification  
Fax Form To: (800) 825-7876**

**ATTENTION!**

Federal record keeping laws require that we maintain a file of owners of our product. Your cooperation in filling out this form will be appreciated.

Change of Owner

Transfer of Limited Warranty  
(see limited warranty for details)

**Model Information:**

Serial#: \_\_\_\_\_

Chassis #: \_\_\_\_\_ Odometer Reading \_\_\_\_\_  
(Motorized only)

**New Owner Information:**

Purchased Date: \_\_\_\_\_

Name: \_\_\_\_\_

Address: \_\_\_\_\_

City: \_\_\_\_\_ State/Province: \_\_\_\_\_ Zip Code \_\_\_\_\_

Phone # \_\_\_\_\_ E-Mail Address \_\_\_\_\_

**Previous Owner Information:**

Purchased Date: \_\_\_\_\_

Name: \_\_\_\_\_

Address: \_\_\_\_\_

City: \_\_\_\_\_ State/Province: \_\_\_\_\_ Zip Code \_\_\_\_\_

Phone # \_\_\_\_\_ E-Mail Address \_\_\_\_\_

**Notes:**